Sustainable Design - High Performance Buildings

Course No: M03-005

Credit: 3 PDH

Steven Liescheidt, P.E., CCS, CCPR



Continuing Education and Development, Inc.
9 Greyridge Farm Court
Stony Point, NY 10980

P: (877) 322-5800

F: (877) 322-4774

info@cedengineering.com



*Chapter 5: Lighting,
HVAC, and Plumbing*

- ❖ *High-Performance Engineering Design*
- ❖ *Lighting System Design*
- ❖ *Mechanical System Design*
- ❖ *Central Plant Systems*
- ❖ *Plumbing and Water Use*
- ❖ *Building Control Systems*
- ❖ *Electrical Power Systems*
- ❖ *Metering*

Chapter 5

Lighting, HVAC, and Plumbing

High-Performance Engineering Design

By now, the building envelope serves multiple roles. It protects the occupants from changing weather conditions and it plays a key part in meeting the occupants' comfort needs. The heating, ventilating, air-conditioning, and lighting (HVAC&L) systems complement the architectural design, govern the building's operation and maintenance costs, and shape the building's long-term environmental impact.

Designers of high-performance buildings depend on building energy simulation tools to understand the complicated interactions between the HVAC&L systems and the building envelope (see Appendix F). These tools also prove invaluable to the designer when comparing HVAC&L strategies and selecting the best systems to meet the building's lighting and space conditioning requirements. High-performance buildings cannot be designed using only rules of thumb or conventional wisdom.

The architectural design maximizes the potential for a high-performance building, but it is the engineering design that actually makes the building a high-performance building.



The LANL Ion Beam Facility mechanical room.

Lighting System Design

The single largest operating cost of commercial buildings in the U.S. is lighting. Lighting systems represent one-third or more of the total electrical energy costs of a commercial building. They also introduce heat into the space and increase building cooling loads. Because lighting systems significantly impact a building's operating cost and energy performance, evaluate options for the lighting systems before considering strategies for a low-energy HVAC system. Also, take advantage of daylighting opportunities whenever possible.

Building Heat Gains from Different Sources of Light

(Watts per 1000 lumens)

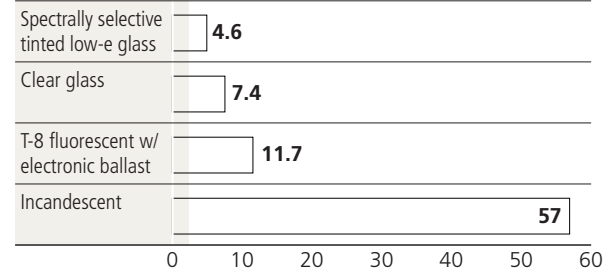

The solar heat gains from a good daylighting system can be less than half of the heat gains from the most efficient current electric lighting system technologies, to achieve equal lighting levels in a space.

Lighting systems constitute 30% to 50% of the total annual electrical energy consumption in U.S. office buildings. In the Federal sector, lighting accounts for 25% of the total electricity consumed annually.

A building designed to take advantage of daylighting will have electric lighting system controls that turn the electric lights off or dim them when sufficient daylighting is available. The electric lights operate only to maintain set lighting conditions that the daylighting cannot meet. Less waste heat from the electric lighting system is then introduced to the space, which in turn reduces the building's cooling loads.

- Saves energy costs and decreases polluting power plant effluents.
- Responds to the varying daylight levels throughout the day.
- Improves indoor environmental quality making occupants more comfortable and productive.
- Tailors to individual's lighting needs throughout the building.
- Decreases building cooling loads resulting in smaller, less expensive space cooling equipment.

HVAC System Design

Space conditioning loads are a close second to lighting systems in terms of the most costly components to operate in commercial buildings in the U.S. Through good architectural design resulting from the engineer participating in the architectural design process, the building will have daylighting, solar gain avoidance, and other energy-efficient architectural strategies. In other words, the envelope will minimize heating, cooling, and lighting energy loads. It is the engineer's responsibility to design the HVAC systems to complement the architectural design.

Remember to account for the benefits of good lighting design – primarily reduced cooling loads – when sizing the HVAC system.

Consider advanced engineering design strategies early in the design process to allow time for making modifications to the architectural design to accommodate these strategies. Use computer simulation tools to evaluate the effect of the advanced architectural strategies when calculating HVAC system loads (see Appendix F). Also, be familiar with the intended building activities and the resulting impact on internal loads.



The LANL Ion Beam Facility mechanical room.

LANL

A well-thought-out building envelope design for the Los Alamos climate will reduce the building's primary lighting, heating, and cooling loads. The engineered systems within the building envelope will meet those additional lighting, heating, and cooling loads that the envelope *cannot* offset. Designing the envelope to be compatible with the climate and designing the engineered systems to truly work with the envelope is a non-traditional method of building design. This method offers considerable potential for achieving high-performance buildings in the uniquely suitable Los Alamos climate.

Plug and process loads impact the HVAC system design, especially in buildings housing energy-intensive laboratory and research activities. Recommend energy-saving equipment options for minimizing these loads. Reducing plug and process loads will decrease internal heat gains from this equipment, reduce building cooling loads, and decrease production of effluents from burning fossil fuels to produce electricity to operate this equipment.

Finally, develop a controls strategy that will operate the HVAC&L systems with the maximum comfort to the occupants at the minimum cost. Metering and evaluation is also important for providing continuous feedback for improvement.

Lighting System Design

The architectural design of a high-performance building maximizes the use of daylighting in the building. The engineering design integrates the electric lighting system design with the architectural design to supplement the changing daylighting levels and maintain constant prescribed lighting levels in the space, using the most efficient lighting technologies and control strategies available.

Always design the lighting system before designing the HVAC system.

The first step in lighting design is to determine the visual needs of the space and identify what type of lighting to use. Lighting types are divided into four categories:

1. Ambient lighting – typically used for circulation and general lighting to give a “sense of space.”

Design ambient lighting systems before designing systems to accommodate the other lighting types.

2. Task lighting – used where clearly defined lighting levels are required to complete detailed work, such as paperwork, reading, or bench-top experiments.

3. Accent lighting – used for architectural purposes to add emphasis or focus to a space or to highlight a display.

4. Emergency or egress lighting – used to provide a pathway for exiting a building if an emergency arises.

Fluorescent Lighting

Fluorescent lighting is the best type of lighting for most applications at LANL (usually linear fluorescent lamps). It can be easily controlled and integrated with the daylighting design.

Linear fluorescent lamps are classified by tube diameter, wattage, color rendering index (CRI), and color temperature, where:

- **Tube diameter** is measured in 1/8" increments (e.g., the diameter of T-8 lamps is 1" and the diameter of T-5 lamps is 5/8").
- **Wattage** is the power required to operate the lamp. The wattage is usually stamped on the lamp itself or on the package in which the lamp

is shipped. Note that the lamp wattage is different from the system wattage, which includes auxiliary equipment such as the ballasts.

- **CRI** is the ratio of the light source to a standard reference source. A CRI of over 80 for a fluorescent lamp is considered very good color rendering, while some high-pressure sodium (HPS) lamps have CRIs in the 20s.
- **Color temperature** gives a general idea of the visual color of the lamp (warm – more red – 2000 to 3000 K, or cool – more blue – 4000 K and above), while color rendering is how accurately a lamp renders colors in the environment.

Ambient Lighting

Ambient lighting systems can be easily integrated with the available daylighting. In a well-designed building, daylighting can offset most or all of the daytime ambient lighting loads. Use the following four steps to design ambient lighting systems.

1. Define the daylighting zones. Evaluate the location of the windows. Align the daylighting zones parallel to the windows with breaks at 5 feet, 10 feet, and 20 feet away from the windows. Place zone separations at corners where windows change orientation. Also, carefully evaluate the daylighting penetration into private offices or other small, enclosed rooms. Light levels measured in daylighting zones will determine how much electric lighting is needed to supplement the daylighting.

2. Define the occupancy zones. The occupancy zones do not necessarily have to match the daylighting zones. The occupancy zone is typically a room, such as a private office or a group of open offices. The sensors located in the occupancy zones turn the electric lights on when the daylighting is not sufficient to meet the prescribed luminance level if there are people in the zone.

A common lighting design error is to supply too much electric light to an area. Proper lighting levels lead to less energy-intensive electric lighting systems and introduce less waste heat into the space, which in turn decreases the space cooling loads.

3. Determine the minimum ambient lighting levels. Design a lighting system to complement the available daylighting in each occupancy zone. The space use will determine how much ambient light is needed (refer to the Illuminating Engineering Society of North America (IESNA) guidelines for detailed lighting level recommendations). The ambient lighting level in good daylighting designs may be less, but provides an equivalent feeling of brightness, than the level conventionally specified for a non-daylit space. Strive to design for less than 0.7 W/ft² for ambient lighting system power densities. Guidelines for determining ambient lighting levels are:

- Provide lower ambient lighting levels in private offices and other areas where the occupants rely on task lighting to complete most of their work.

The key is light, and light illuminates shapes, and shapes have an emotional power.

– Le Corbusier



Douglas Balcomb

Daylighting is the primary source of ambient light within the Harmony Library in Fort Collins, Colorado.

- Provide higher ambient lighting levels in densely occupied work areas. Distribute the ambient light uniformly in these spaces from directions that will minimize glare and reflections on the work surface. For example, position workstations between the rows of ceiling-mounted luminaires. Light coming from the sides of rather than directly in line with the viewing direction will reduce veiling reflection potential.
 - Plan for fluctuating lighting levels in daylit circulation spaces, as long as the minimum lighting levels allow for safe movement when there are people in the space. All circulation spaces can have sensors to turn the electric lights off when daylight is available or when the space is not occupied.
- 4. Select lighting fixtures.** Fixture designs can provide high lighting efficiency while also meeting the

other lighting objectives of the installation. Use efficient fixtures with appropriate distribution, glare control, and visual characteristics for the lowest possible power input. Work with the architectural designers to select fixtures that achieve the desired ambient quality while minimizing lighting energy requirements. Also, select fixtures that are capable of dimming the light output so they only supply the light needed to supplement available daylight.

- Direct, ceiling-recessed fixtures are commonly used in office and laboratory spaces; however, their use is discouraged because of poor lighting quality. If these fixtures must be used with a ceiling plenum-type return air stream, select fixtures with heat removal capabilities. The light output of fluorescent lamps decreases when operating at temperatures

higher than room temperature. Ventilated fixtures help keep the lamps at a lower temperature, thereby allowing the lighting equipment to operate more efficiently by directing some of the heat from the lamps into the return air stream instead of into the space.

- Indirect lighting fixtures provide very uniform light levels, eliminate excessive reflections on the task, and minimize shadows (especially from the head and hands). They provide good flexibility for future space rearrangements because of the uniform light level. Indirect lighting fixtures use about 15 percent more energy than direct fixtures to achieve a given lighting level because the light must bounce off the ceiling. However, indirect lighting fixtures provide a better quality of light, so the lighting levels and power densities can be reduced.

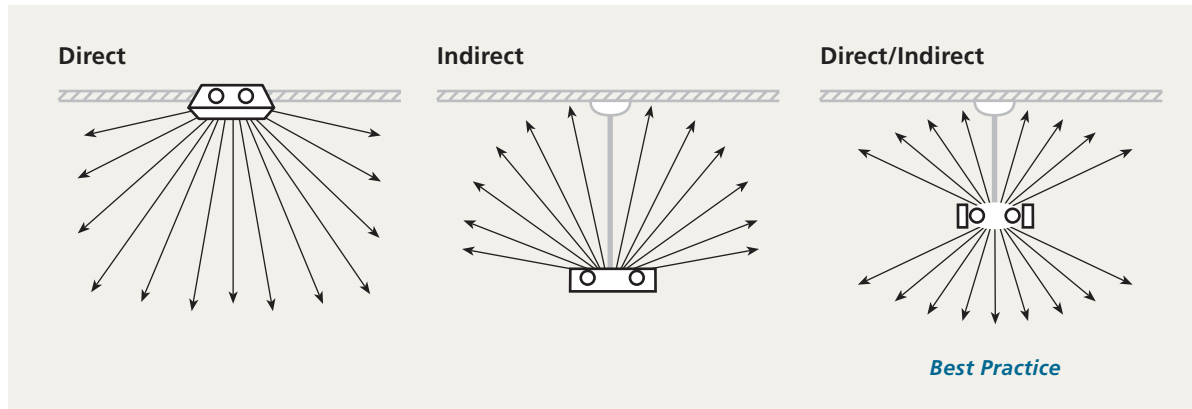

Direct/indirect lighting fixtures, recommended for ambient lighting systems, require the fixture to be mounted about 18 inches below the ceiling to provide uniform luminance. Increased ceiling height may be needed.

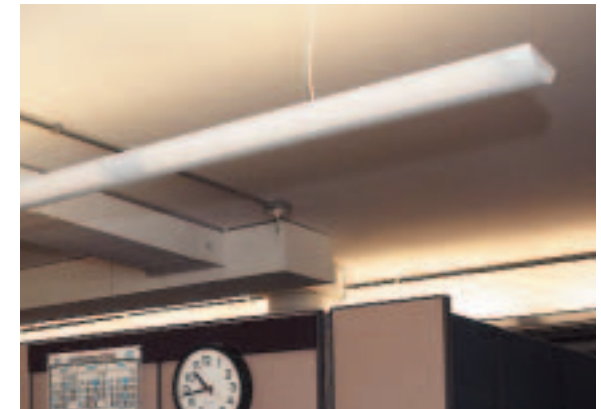

Indirect lighting fixtures with T-5 lamps in the LANL PM Division offices reduces glare and provides more uniform ambient light.

L. Brooke Davis

- The recommended lighting fixture for most LANL applications combines the direct and indirect approaches. These fixtures provide both upward and downward light. Their efficiency is about equal to a

Standard HID lamps do not work well with daylight or occupancy controls because of the long starting and restrike times. Consider HID lighting in high bay areas with no daylight that need to be continuously illuminated, and for exterior applications.

good direct lighting fixture with the uniformity and glare control of indirect lighting. The direct portion can provide some brightness and adequate shielding to provide good visual comfort and avoid glare. Ideally, the indirect portion does not create hot spots or excessive luminance on the ceiling. Typically, the best direct portion is 20 percent to 50 percent of the light, while the remainder is indirect.

Select direct/indirect fixtures that allow airflow through the fixture past the bulbs to minimize dirt accumulation. Note that not all direct/indirect fixtures are designed to resist dirt accumulation.

Task Lighting

Task lighting provides additional illumination to areas where individuals perform difficult visual tasks, such as working at a desk or completing detailed laboratory activities. Steps to designing good task lighting systems are:

1. **Determine where task lighting is needed.** To achieve the most energy savings, use separate lighting fixtures to provide additional task lighting only where the building occupants need it instead of



Robb Williamson

Direct/indirect lighting fixtures supplement daylighting to maintain constant luminance levels in this classroom within the Lewis Center for Environmental Studies at Oberlin College in Oberlin, Ohio.

depending on the ambient lighting system to provide enough light to complete detailed tasks.

- 2. Balance task and ambient lighting levels.** To help maintain visual comfort, the task illumination must not be more than three times that of the ambient illumination.
- 3. Provide automatic and manual controls.** Task lighting is best controlled with occupancy sensors and manual user controls.

Accent Lighting

Accent lighting highlights aesthetic features in the space or give the space a certain desired “feel.” Accent lighting system design guidelines are:

- 1. Limit the amount of accent lighting.** For the amount of useful light it provides, accent lighting often consumes more power than ambient or task lighting systems.
- 2. Use occupancy sensors to control accent lighting.** Ensure that the accent lighting is on only when there are people in the space.
- 3. Select low-energy fixtures.** Select the lowest-wattage fixtures possible to achieve the desired effect for all accent lighting.
- 4. Balance accent and ambient lighting levels.** Reduce the ambient lighting levels near accent lighting to improve contrast.



Sheila Hayter

Control task lighting with occupancy sensors so that the lighting is on only when additional light is needed to complete detailed work.



Robb Williamson

Carefully select accent lighting fixtures and controls so that the lighting provides the desired aesthetic value and energy efficiency.

Safety Lighting

Safety lighting (sometimes called “emergency lighting”) allows people to enter a space, occupy it, and move through or exit it without endangering their physical well-being. Building codes require that potential hazards, circulation areas, entrances, and exits must be illuminated. Guidelines for designing safety lighting systems are:

- 1. Select low-energy safety lighting fixtures.** Use high-efficacy lamps in efficient fixtures and provide safety lighting only to the required lighting level.
- 2. Operate safety lighting only when needed.** Use occupancy sensors and photo sensors to control safety lighting.
- 3. Place all safety lighting on separate lighting circuits.** Separating circuits leads to the ability to turn off the safety lighting when it is not needed.



Warren Gretz

Exit signs operate 24 hours per day every day of the year. Because buildings will have many exit signs, it is best if each sign consumes 2 watts or less. The LED exit sign shown here is an example of a 2-watt sign.

The Thermal Test Facility at the National Renewable Energy Laboratory has no 24-hour safety lighting. Instead, the interior lights turn on when the occupancy sensors detect motion within the building; otherwise the building is totally dark. Approximately 2,630 kWh/year are saved by not operating 10% of the electric lighting 24 hours per day, the typical percentage of lighting dedicated to security lighting in commercial buildings. The security lighting controls also save the security personnel time when patrolling the site after dark. The security personnel do not need to enter the building during routine patrols unless the lights are on, indicating to them that someone has entered the building.

Lighting Controls

Lighting controls match the light output to the occupancy schedule and illumination requirements. The controls minimize the actual energy consumption without compromising the quality of lighting in the space. There are two types of controls:

- ❑ **Manual controls** are appropriate for spaces that have lamps with long starting and restrike times, such as high-intensity discharge (HID) lamps. They may also be appropriate for spaces that require occupant light control, such as equipment rooms and laser laboratories; however, manual controls are usually not recommended.
- ❑ **Automatic controls** are more appropriate for spaces where daylighting is the primary lighting source and spaces having differing occupancy schedules, such as offices, break rooms, and restrooms.

On-off or step-function lighting controls are best suited for spaces where occupants are in the space for a short period or when sudden shifts in lighting levels will not

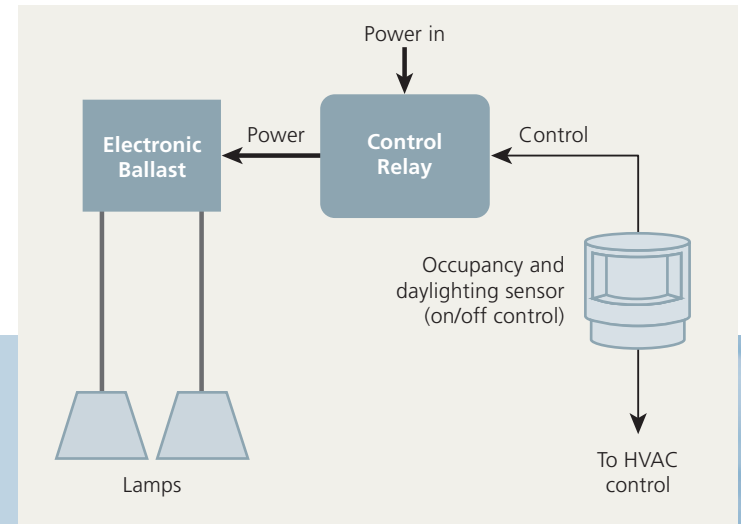

On/off with daylighting control: Motion and daylight trigger the lighting control. This type of control is ideal for common areas and hallways.

disturb the occupants. Circulation areas, restrooms, interior laboratories, and service rooms are good candidates for on-off or step-function lighting controls. These lighting control functions can be either manual or automatic.

Dimming function lighting controls are best suited for blending electrically generated light with daylight to provide the designed illumination level. Conference rooms and interior private offices with no daylighting are examples of the few places where manual dimming is appropriate. In these special cases, an occupancy sensor turns the electric lights on and off and the occupants may have manual dimming controls to set the lighting at the appropriate level.

The best dimming controls are automatic and continuous. Continuous dimming avoids instantaneous jumps in lighting levels that can be distracting to the occupant. Ideally, the lighting control system is capable of dimming the lights based on lighting level, and turning off the lights if the space is unoccupied.

Effective Lighting System Design

1. Review the F&OR document for the space use description.
2. Define the reason for the lighting.
 - Ambient- circulation and general lighting
 - Task- areas where detailed work is done
 - Accent- architectural use only (minimal)
 - Safety or emergency egress lighting
3. Design the ambient lighting system.
 - Define daylighting zones
 - Define occupancy sensor zones
 - Determine minimum ambient lighting levels
 - Select lighting fixtures
4. Design the task lighting system.
 - Determine where task lighting is needed
 - Balance task and ambient lighting levels
 - Provide automatic and manual controls
5. Design the accent lighting system.
 - Limit the amount of accent lighting
 - Use occupancy sensors to control accent lighting
 - Select low-energy fixtures
 - Reduce ambient light levels when there is accent lighting
6. Design the safety lighting system.
 - Select low-energy safety lighting fixtures
 - Operate safety lighting only when needed
 - Place all safety lighting on separate lighting circuits
7. Design the lighting control system, using automatic and dimmable controls.
8. Verify the design by evaluating lighting power densities W/ft².

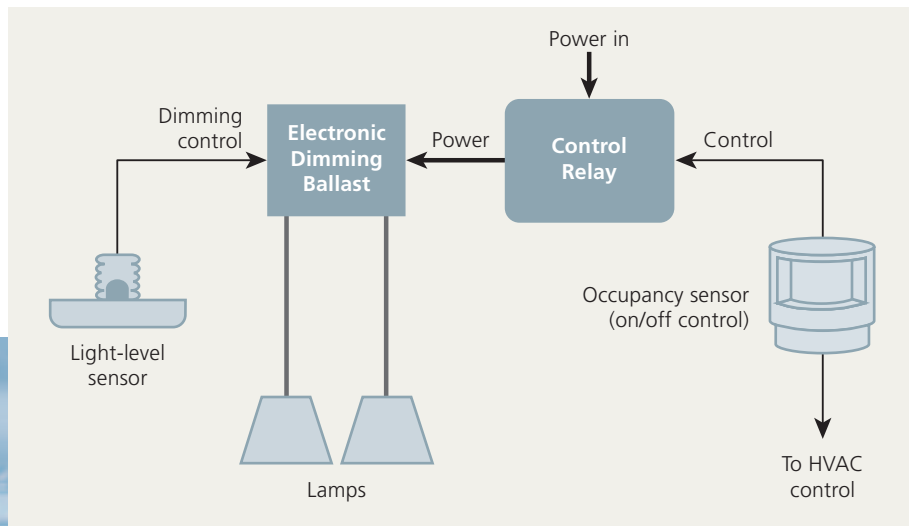

Dimming control: Lighting controls incorporating an occupancy sensor to turn lights on/off and a light-level sensor to dim the lights based on available daylight.

Mechanical System Design

The HVAC systems maintain a comfortable and healthy indoor environment by responding to the loads imposed by the building's envelope design, lighting system design, and occupant activities. Proper design of the control schemes for the systems that heat and cool the interior spaces, provide fresh air for the occupants, and remove contaminants from the building will ensure that the HVAC system operation complements the architectural and lighting designs and minimizes building energy consumption.

HVAC System Zones

Determine the minimum conditions, such as temperature and humidity requirements, for all spaces in the buildings. Group spaces having similar space conditioning requirements into one zone, then separate the HVAC systems into zones based on these expected loads. When identifying HVAC system zones:

- Separate systems serving office areas from those serving laboratory or process areas.
- Separate areas with relatively constant and weather-independent loads (e.g., interior offices or interior light laboratory spaces) from perimeter spaces.

- Separate areas with special temperature or humidity requirements (e.g., computer rooms) from those areas that require comfort heating and cooling.

Identify the space loads to determine the capacity of the HVAC equipment for each zone. Typically, envelope loads dominate the heating and cooling loads of perimeter zones and equipment loads dominate the interior zone loads.

Carefully calculate the HVAC system loads using computer simulation tools (see Appendix F). Especially in high-performance buildings, it is difficult to accurately estimate system loads using "rules of thumb," such as sizing an air-conditioning unit's capacity assuming that so many tons of cooling are needed per square foot of building floor area. It is important to use computer simulation tools to assist with making engineering design decisions.

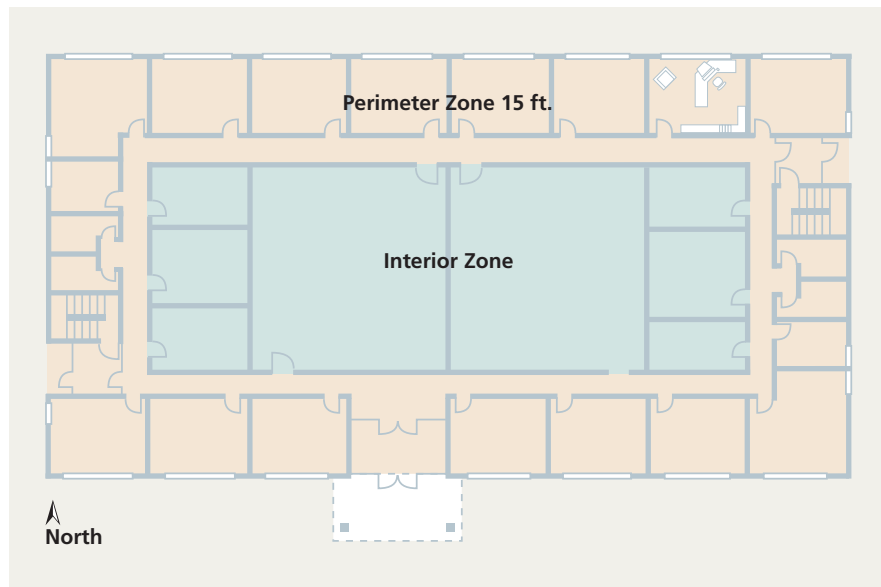

Typical HVAC zone design for a building with perimeter offices. Perimeter zones can extend from the exterior wall to the first interior wall, or for open floor plans, up to 15 feet from the exterior wall.

Evaluate the predicted peak loads when completing the heating and cooling loads calculation – when and why they occur. A thorough analysis of the peak loads often leads to design solutions that further decrease building energy loads. The following points exemplify why peak load analysis is important.

- When using daylighting to offset lighting loads, the peak cooling month will often shift from a summer month (such as for a conventional building) to October. This non-intuitive peak loading occurs because the sun is low in the sky during October so that overhangs no longer shade the building, yet the daytime outdoor temperatures are still high enough that cooling will be needed. One solution to this late-season cooling load is to use outside air to cool the building, by means of an economizer, natural ventilation, or precooling the building by night flushing.
- A winter morning peak load may occur during the building warm-up period. One solution is to design a heating system to accommodate this peak load, but this system will then operate at part load for most of the time. Another

solution is to downsize the heating system so that it is operating near full capacity during a typical heating day. Begin the morning warm-up period earlier in the day to decrease the system peak load to that which the system can handle. The system then has a longer time to heat the building before the occupants arrive. Compare the lifetime operating costs of these and other scenarios before determining the best solution.

- A peak load analysis may show the largest cooling loads occurring late in the afternoon because of solar gains through west-facing windows. It may be that changing the specified glass characteristics (to those that reduce the amount of solar gains entering a space, see Chapter 4) of these windows will help reduce the cooling load. Another solution could be to shade the windows from the outside with an architectural screen. Or, the solution may be to reduce the glazing area on the west facade.

Perimeter Zones

The wall, roof, and floor insulation and the heat transfer characteristics of the window glass will affect the perimeter zone heating and cooling loads. In a well-designed building, the architectural features of the envelope will shade the building to minimize direct solar gains and reduce perimeter-zone cooling loads.

It is likely that daylighting will be available in the perimeter zones. Interior zones may have daylighting if clerestories, roof monitors, light tubes, or other strategies are used to bring daylighting to the space (see Chapter 4). Remember to accurately evaluate how daylighting will affect the zone loads. A good daylighting design will decrease the internal heat gains from operating electric lighting systems and introduce little or no adverse solar gains. Reducing the internal and solar heat gains decreases cooling loads and potentially increases heating loads.



Placing the windows deep in the south-facing wall helps to shade the window to minimize direct solar gains and reduce perimeter cooling loads.

LANL

Interior Zones

Internal loads from people occupying the space and waste heat from operating electric lighting systems and equipment in the space typically determine the interior-zone heating and cooling loads. Reduce internal loads as much as possible by reducing the lighting loads. Use efficient lighting fixtures and control the lighting to operate only to provide the lighting level needed when

the space is occupied. Also, select energy-efficient equipment (e.g., office or process equipment), or recommend specific energy-efficient equipment for the user to purchase.

Plug loads are loads from the individual pieces of electrical equipment that can be removed from the building and powered through electrical wall outlets. Process loads are the loads produced by the process equipment in a space. When operating, both plug and process loads introduce heat to the space and increases load on the building's cooling system. The first step to reducing plug and process loads is to ensure that the equipment is turned off or set to a "sleep" mode when not in use. For example, always enable the power saving features for computer equipment. In addition, it is best that all new equipment be ENERGY STAR® rated or of the highest available efficiency.

Be sure to accurately calculate the magnitude of plug and process loads. Consider the average instead of the peak energy use for this equipment when determining the maximum internal gains, unless all the equipment will be simultaneously operating at peak power draws. If the equipment to be used in a new building is similar to equipment in an existing building, base the estimated loads on the measured average energy use of that existing equipment.

Internal Loads and Supply Air Flow

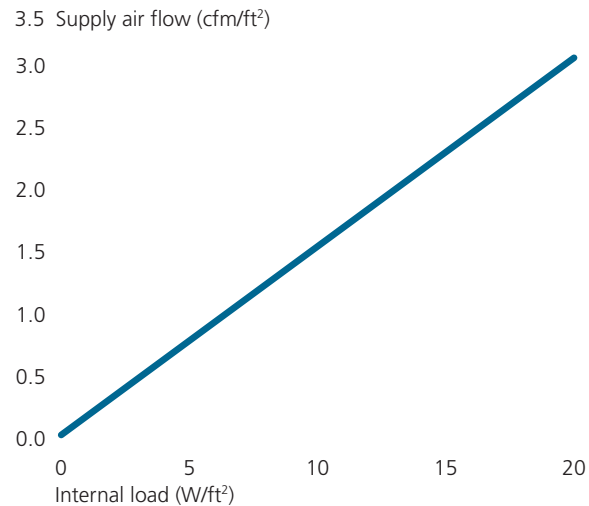

Quantity of 55°F supply air required to offset internal loads.

Flat screen monitors save energy

Flat screen computer monitors use a fraction of the energy of traditional monitors, which means they introduce less waste heat to the space. They also reduce the incidences of complaints about glare, making them the better option in spaces where occupant workstations may be rearranged without regard to the locations of entering daylight or electric lighting fixtures.



Sheila Hayter

Ventilation Systems for Zones

Ventilation air requirements often vary between zones. Ventilation is the use of outdoor air for controlling containment concentration by dilution or sweeping the contaminants from their source. Ventilation should meet the recommended values of ANSI/ASHRAE Standard 62-1999, 15 to 20 cubic feet per minute (cfm) per person, or the performance criteria described in the Standard using demand-control ventilation systems.

Demand-controlled ventilation reduces outside air requirements to the minimum needed for the actual zone occupancy when the zone would not benefit from economizer operation. Demand-controlled ventilation can greatly reduce the heating and cooling required for

treating outside air. Carbon dioxide sensors are a useful indicator of the concentration of human bioeffluents and work well for regulating ventilation air rates. Use multiple sensors to ensure proper ventilation in densely versus lightly occupied spaces. As a general rule, place one sensor for the return air stream of the air handling unit and one sensor for each densely occupied space to ensure proper ventilation per minimum requirements and provide opportunities for increased energy savings.

Use higher levels of ventilation (e.g., economizers) as a substitute for mechanical cooling when ambient conditions allow for this “free” cooling. During the heating season, continue to use cool outdoor air to offset cooling loads that occur in interior zones. For the zones that require heating, reduce the ventilation air rates to

the lowest volume possible and still maintain adequate indoor air quality to minimize the amount of cold air that must be heated before delivering it to the space.

It is common for separate zones within a building to experience opposite loads during the same period. For example, an interior zone may call for cooling while a perimeter zone requires heating, or an office zone may require very different conditions than a laboratory zone. To satisfy the space conditioning requirements of all spaces using the least amount of energy, separate the HVAC systems to serve zones with dissimilar heating and cooling patterns. Also, keep control zones small, especially when expecting a large difference in internal loads.

According to ANSI/ASHRAE Standard 62-1999, “Where peak occupancy of less than three hours duration occurs, the outdoor air flow rate may be determined on the basis of average occupancy for buildings for the duration of operation of the system, provided the average occupancy used is not less than one-half the maximum.” Spaces having intermittent or variable occupancy may then have lower ventilation rates than would be required if the peak occupancy were used to determine the amount of ventilation (e.g., a conference room). It is better to use CO₂ sensing to control the amount of ventilation air needed during any particular period versus supplying 15–20 cfm per person for the average expected occupancy. Changing the ventilation rates with the changing occupancy will result in lower energy consumption and improved occupant comfort.

Energy Usage of Modeled LANL Building with and without an Economizer

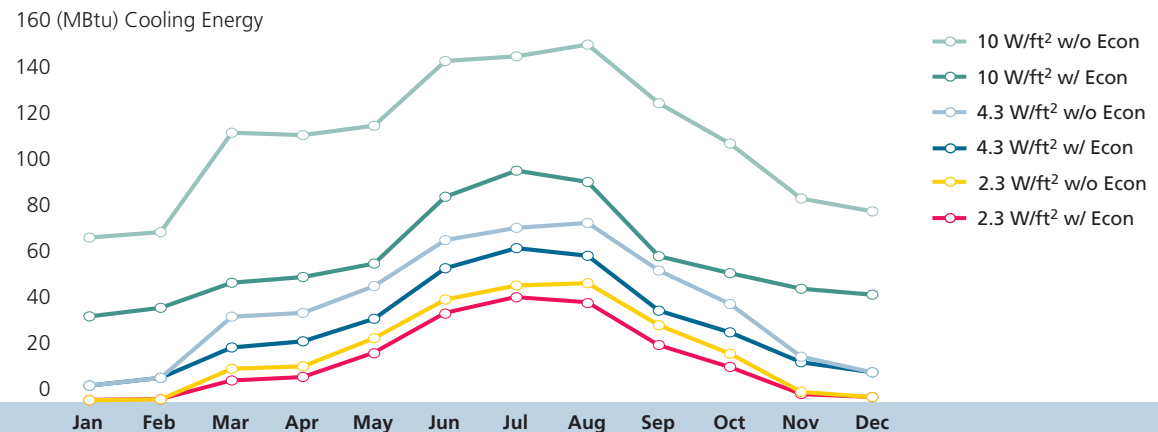

Energy use of a simulated LANL office/laboratory building with and without an economizer. The chart shows the results of three simulations: the building with internal loads set to 2.3 W/ft², 4.3 W/ft², and 10 W/ft². The annual energy savings from using an economizer for the building with internal loads set to 2.3 W/ft² is 51.7 MBtu, which corresponds to a 20% energy savings.

HVAC System Selection

Select the system type after completing a thorough analysis of the heating and cooling loads and the varying ventilation requirements of each zone. Evaluate several types of HVAC system options to identify the system that will satisfy the zone's temperature and humidity requirements using the least amount of energy.

VAV Systems

VAV systems moderate space conditions by varying the amount of air delivered to the space. For most LANL buildings, variable-air-volume (VAV) systems will best meet space conditioning requirements of each zone. This is true for both office spaces and laboratory spaces. For example, occupants of each office or group of offices may have varying temperature demands

compared to their neighbors. Also, one laboratory may call for high levels of exhaust air flow, while a neighboring laboratory may be unoccupied and require very little exhaust airflow.

Use induction VAV units for interior zones and fan-powered VAV units with hot-water reheat coils for perimeter zones. Be sure to select a reheat coil rated for low-airside and low-waterside flow resistances. In addition, recommended perimeter zone VAV units are "parallel flow" fan-powered (the VAV box fan is only on during the heating mode and is off during the cooling mode). Control the perimeter heating system operation so that it can maintain minimum space conditions during unoccupied hours without requiring the main air-handling unit (AHU) fan to also operate.

Dedicated hot water heating systems are often used in perimeter zones of LANL buildings to offset the heat losses through the building envelope.

The diverse requirements for laboratory spaces also hold for internal loads. This is another important reason to use lab VAV systems. The VAV system can control the amount of "economizer" that is required to meet loads.

...the underlying purpose of the building is neither to save nor use energy. Rather, the building is there to serve the occupants and their activities.

– FEMP Low-Energy Building Design Guidelines

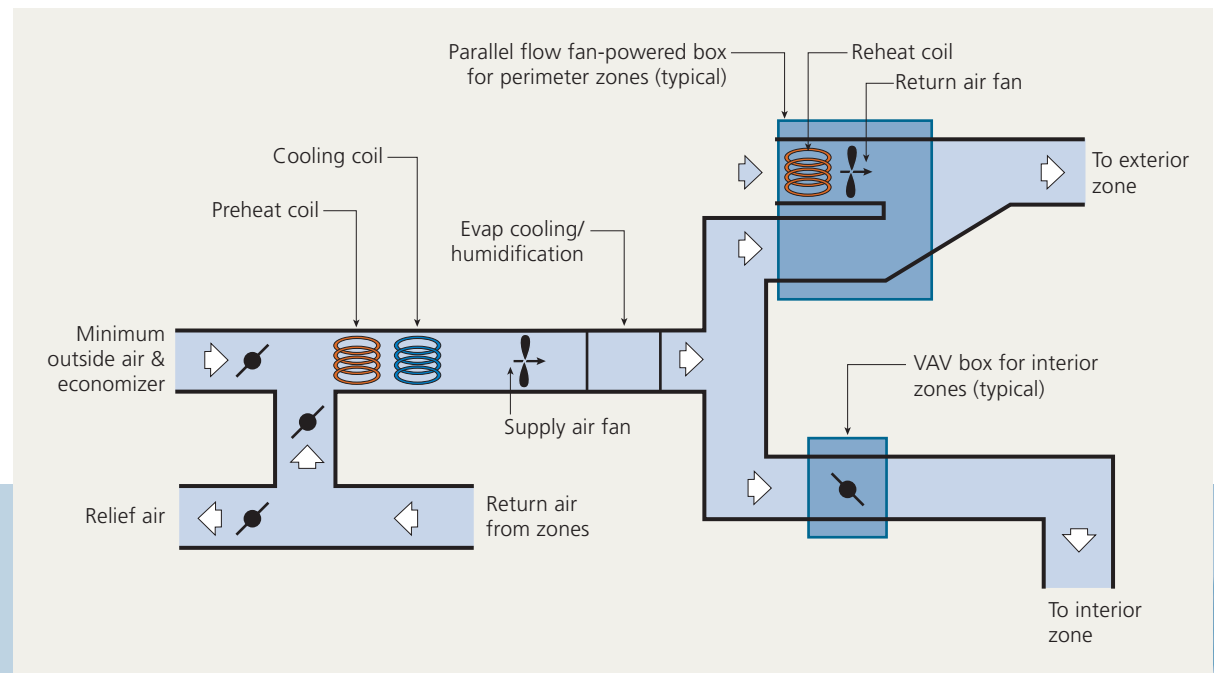

Use variable air volume induction units to condition interior zones and fan-powered perimeter reheat VAV units to condition perimeter zones.

Air-Handling Unit (AHU) Design Guidelines

- **Fan selection** – In most cases, vane-axial and backward-curved centrifugal fans are the most efficient AHU fan choice. Consider the rated acoustical properties, space limitations, inlet and outlet conditions, and air quantities/pressure requirements of the fan before identifying the best fan for the application.
- **Coil and filter selection** – Select AHU coils for low airside and waterside flow resistance, low water flow rates, and operation at warmer chilled water or cooler hot water temperatures. Specify coil control strategies that will minimize water flow and maximize heat transfer. Pay special attention to the pressure drop of coils and filters. Limit face velocity to 450 feet per minute (fpm) for VAV systems and 400 fpm for constant air volume systems.
- **Hot and chilled water piping systems** – Increasing the system pipe diameters and specifying low-friction valves reduces flow resistance through the piping and coils and decreases the system pumping energy.
- **Air distribution systems** – Select air distribution components that offer the lowest pressure drop through the system. Large duct sizes provide low pressure drop and future flexibility if increased airflow is required. Try to minimize fittings such as elbows and transitions, since they have large pressure drops.

Air Distribution Systems

The two types of air distribution systems that are likely to be considered for most LANL buildings are overhead and under-floor air distribution systems.

- **Overhead air distribution systems** deliver conditioned air through ducts above the ceiling and then to the space through overhead diffusers. These conventional distribution systems typically deliver 50°F to 55°F supply air. They rely on the properties of the diffuser to throw the conditioned air to mix with the room air and maintain comfort at the occupant's level (e.g., at desk level in a typical office space).

Well-designed overhead air distribution systems have little variance in the floor-to-ceiling space temperatures.

- **Under-floor air distribution systems** use a plenum under a raised floor to distribute air to a space. The systems typically deliver 60°F to 65°F supply air through diffusers in the floor. The systems then rely on stratification to move the warm air above the occupant's level to be replaced by the cooler conditioned air. There is typically a large temperature variance between the conditioned air temperature at the floor and the warmer air temperature at the ceiling. Under-floor air distribution systems can be installed with little or no first-cost penalty, and operational savings will occur over the life of the systems.

Fan Energy (76% efficiency)

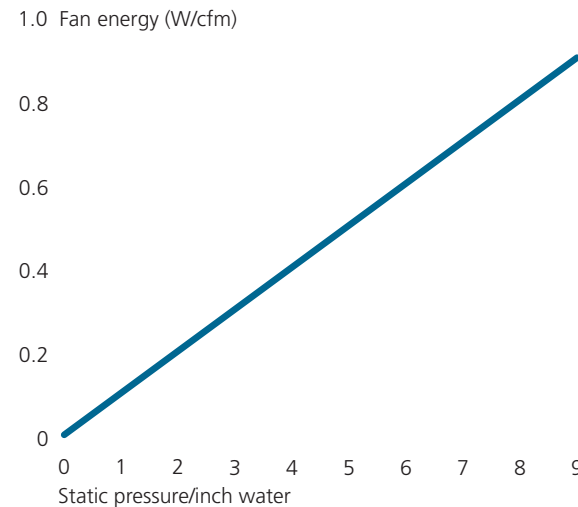

Fan energy increases with higher pressure drops through the air distribution system. Understand how fan properties will affect system energy consumption before selecting fans.

Under-floor air distribution systems can lead to improved thermal comfort, improved indoor air quality, reduced HVAC system energy use, and increased flexibility of the office space.

- Increased personnel comfort is possible because personal control of airflow can be relatively easily incorporated into the system design.
- HVAC system energy savings result from reduced ventilation air rates. Cleaner air can be delivered directly to the occupants without dilution with existing room air (displacement ventilation), compared to

overhead systems that deliver air at the ceiling and then mix with room air.

- The higher supply air temperatures of under-floor air distribution systems allow more hours of economizer operation, increase chiller plant efficiency, and decrease the run-time of mechanical cooling equipment.
- The under-floor air distribution plenum often doubles as a wire management corridor, increasing the space reconfiguration flexibility.

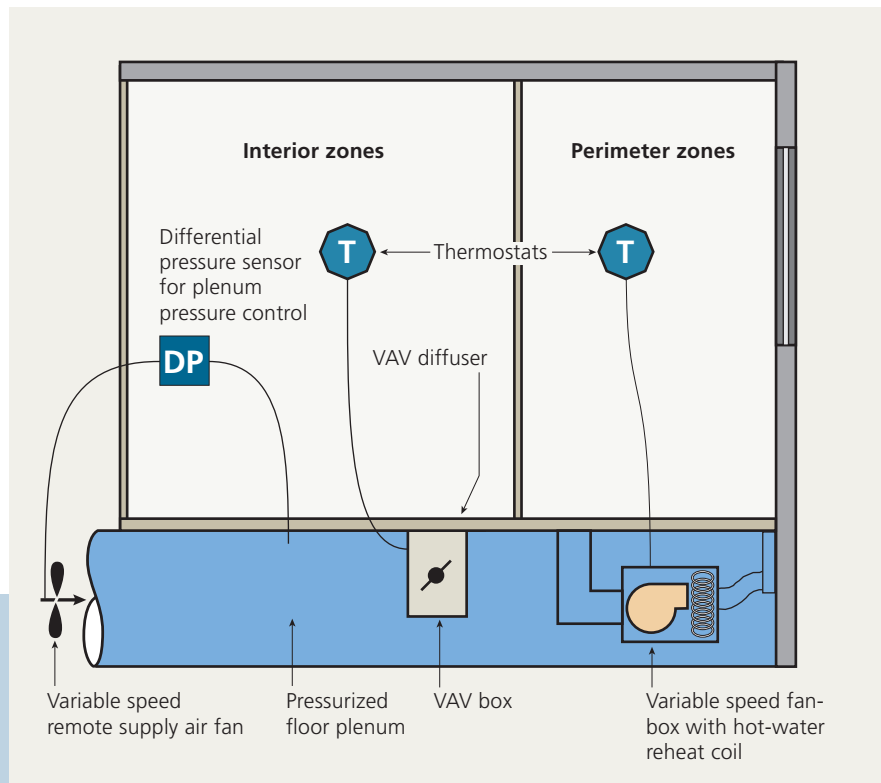

VAV under-floor distribution system with plenum pressure control and perimeter fan-powered heating unit. Under-floor air distribution systems are more flexible, provide greater occupant control, and use less energy compared to overhead air distribution systems.

-Floor Air Distribution

- Evaluate under-floor air distribution systems early in the design process during the conceptual design phase.
- Consider under-floor air distribution systems for spaces having a high density of information technology equipment, office spaces, or spaces that are expected to undergo frequent reconfigurations.
- Minimize pressurized plenum air leakage by sealing all plenum penetrations and specifying low-air-leakage (tight) raised floor systems.
- Use VAV controls for all under-floor air systems to control plenum pressure.
- Use variable speed fan units and reheat in the perimeter zones if additional heat is needed in these zones.
- Deliver adequate supply air quantities to meet the loads. Supply air quantities do not differ greatly between conventional overhead and under-floor air distribution systems.

“Free” Cooling Systems

The high diurnal temperature swings and low humidity levels prevalent at Los Alamos are ideal conditions for “free” cooling (see Appendix B). Free cooling is accomplished by delivering outdoor air to cool buildings instead of relying on mechanical cooling systems. These systems can significantly decrease compressor, cooling tower, and condenser water pump energy requirements as well as tower makeup water use and the related water treatment. Free cooling has the added benefit of providing a high level of ventilation air to a space, often resulting in improved indoor air quality.

- ❖ **Air-side economizer systems** – A mixing box capable of handling 100 percent outside air integrated with the HVAC system is an economizer system. The amount of outside air brought in to the building through these systems is limited by the outside air conditions (usually just temperature in Los Alamos) or requirements for ventilation air (based on indoor CO₂ levels). Note that laboratories requiring 100 percent outside air are always in “economizer” mode.

- ❖ **Nighttime precooling (night purge) systems** – Use of nighttime precooling (night purge) reduces daytime mechanical cooling requirements. Flushing

the building at night with outside air cools the building mass, which will stay cool through the beginning hours of building occupancy. When operating a night purge system, let the building temperature float during the first part of the night then run the system fans for the few hours prior to occupancy to precool the building to the desired temperature.

- ❖ **Natural ventilation systems** – Natural ventilation relies on the air movement through the space without the use of fans to cool the building. Consider natural ventilation early in the design process to ensure that the architectural design incorporates strategically placed, operable windows to accommodate natural ventilation systems. Many times, operable windows are automatically controlled to promote natural ventilation only when the outdoor conditions are suitable and to ensure that all operable windows close if fire or smoke are detected in the building. Using natural ventilation whenever an economizer is operating would also be appropriate.

Evaporative Cooling Systems

In evaporative cooling, the sensible heat in an air stream is exchanged for the latent heat of water. Most buildings at LANL could be cooled by evaporative cooling methods alone.

Direct evaporative coolers (also known as swamp coolers) introduce some moisture to the air stream, subsequently reducing the dry bulb temperature of the outside air to within 5°F to 10°F of the wet bulb temperature. *Indirect evaporative coolers* provide sensible cooling only. Air cooled by water sprayed on the backside of a heat exchanger is separate from the air delivered to the occupied space.

Indirect/direct evaporative cooling systems pass air through an indirect evaporative cooling system heat exchanger to provide sensible cooling to the air stream

Evaporative cooling has been somewhat limited at LANL because of hard (high silica) water. Evaporative cooling systems are practical at LANL if a water treatment technology that cost-effectively removes the silica from the water is employed. If water treatment is to be installed for research purposes, then consider increasing the capacity of this treatment system to also provide water for evaporative cooling.



before it reaches the direct evaporative cooling section of the unit. These systems are often sized so that small to medium cooling loads can be met with the indirect section operating alone. The indirect/direct sections operate together to meet larger cooling loads.

Both direct and indirect evaporative cooling systems can be modified to improve the performance of other cooling systems. Direct evaporative cooling systems can extend the range of economizer cycles by pre-cooling the air stream. An adaptation of indirect evaporative cooling systems is to circulate cooling tower water through a coil installed in an AHU to provide sensible cooling. This type of indirect system is often augmented with a chiller to provide enough cooling capacity to meet peak loads.

Ventilation and Exhaust Systems

Rooms with exhaust air systems, such as kitchens and restrooms, can draw air from adjacent occupied spaces to replace the exhausted air. This approach has two benefits:

1. Rooms where odors may be an issue are kept at lower pressure than surrounding spaces, minimizing the potential for odors to spread.

Space Heating at LANL

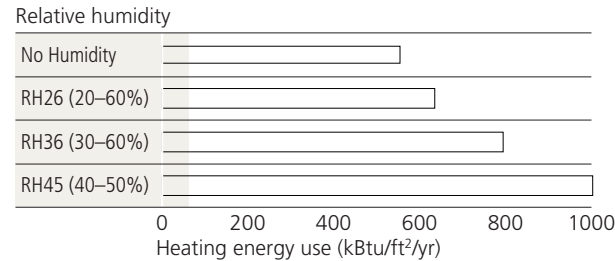

Tight control of humidity levels in a lab building at LANL with a high ventilation rate has a huge heating energy penalty. Assuming an average flow rate of 2 cfm/ft² and no heat recovery, the heating energy use almost doubles if humidity is controlled to between 40% and 50% relative humidity (RH) (RH45) compared to not controlling humidity (No Humidity). Controlling between 30% and 60% (RH36) and between 20% and 60% (RH26) has a lower, but still significant, energy penalty.

2. Ventilation air is distributed to occupied spaces before being exhausted, thereby reducing the required ventilation air.

Laboratory buildings having hazardous materials may need large quantities of exhaust and makeup air for safety reasons. Conditioning and moving large quantities of air will dominate the energy use in laboratory buildings.

Because of the diversity of laboratory spaces, it is recommended that each space have a fan coil for heating and cooling (if high internal loads are expected). A fan coil is preferred over a reheat coil located in the makeup air duct. A fan coil configuration does not require circulation of a large volume of air through a reheat coil, which results in an air system pressure drop, 365 days a year.

Consider potential contamination sources when locating outside air intakes for building ventilation air. Exhaust fan discharge, plumbing vents, cooling towers, and combustion products from vehicles and equipment (e.g., boilers and generators) are examples of contami-

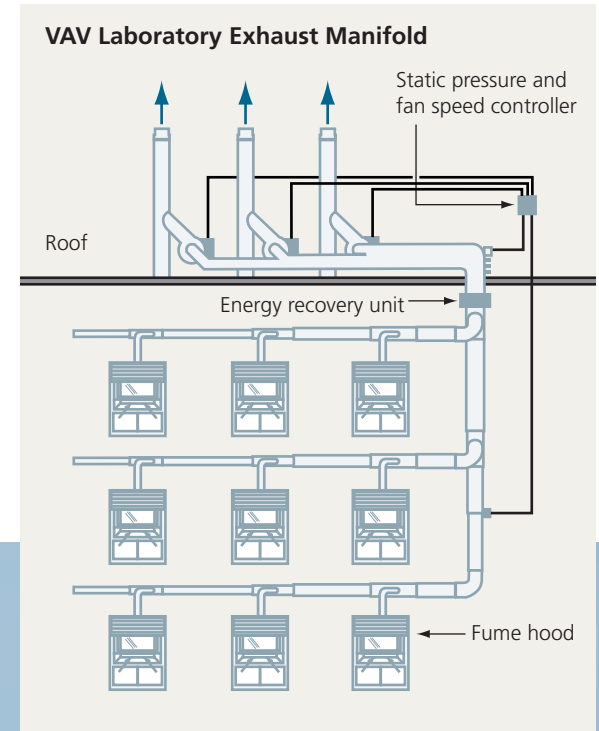

VAV Exhaust System Controls

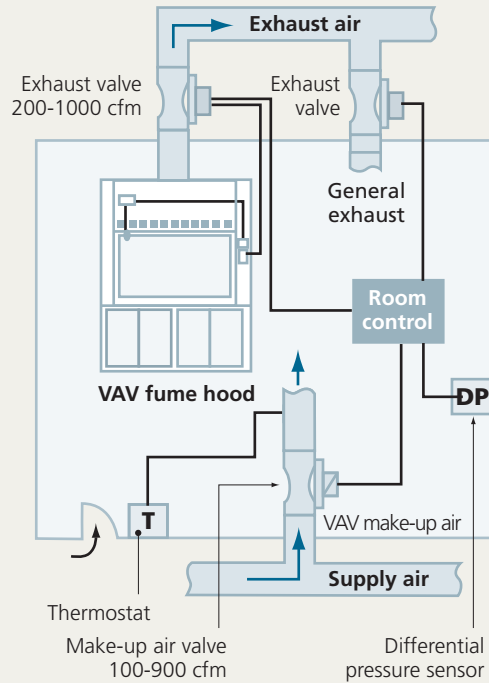

Store and use hazardous materials only in exhausted enclosures such as chemical storage cabinets and fume hoods. It takes less energy to remove a contaminant at the source than to condition and supply enough ventilation air to dilute the contaminant. As a rule of thumb, control concentrated contaminant sources at the source by containment, local exhaust systems, or both. In many laboratory cases, this containment and local exhaust is accomplished by using fume hoods.

The fume-hood-exhausted enclosures only need to draw enough exhaust air to maintain a negative pressure when not in use; however, when in use the exhaust rate typically increases. For example, a fume hood sash that remains closed when not in use could draw about 40 cfm per linear foot. When the fume hood sash is open, the flow must be enough to meet ASHRAE Standard 110 containment requirements, typically about



Labconco

60 fpm for new low-flow fume hoods. Use VAV supply and exhaust systems to minimize the quantity of air flowing through the fume hood and other exhaust devices.

nation sources. Perform effluent plume models using wind tunnels or Computational Fluid Dynamics (CFD) software programs to predict plume paths and help locate air intakes and exhausts.

Design laboratory exhaust systems as a “manifold” exhaust. Manifold exhaust systems provide substantial energy and first-cost savings. This system offers opportunities for centralized energy recovery, and better dilu-

tion. Use multiple exhaust fans and stacks with the laboratory VAV system for redundancy and to maintain a constant stack discharge velocity as system volume varies. Constant stack discharge velocity is maintained by operating only the required number of fans to match the current exhaust system load.

Air-to-Air Energy Recovery Systems

Air-to-air energy recovery opportunities exist at LANL in buildings with high ventilation loads. In air-to-air energy recovery systems, exhaust air and outdoor air both pass through a heat exchanger where the exhaust air preconditions the outdoor air entering the building. These systems reduce the heating and cooling peak energy demands and can reduce the heating energy consumption of buildings by 30 percent to 50 percent.

Effective use of energy recovery devices results in decreased loads on the heating and cooling mechanical equipment. Equipment with reduced capacities can then be purchased. The savings gained from purchasing smaller equipment often exceeds the first cost of the energy recovery devices.

Air-to-air heat exchangers increase the fan power needed to supply the outside air to the building and to discharge the exhaust or relief air from the building. Even though the fan energy increases, the total energy use of the system decreases because the overall heating and cooling system energy use decreases. Including a bypass damper to redirect the air around the recovery device when the outdoor conditions do not warrant energy recovery improves the performance of these energy recovery systems.

Locate the outside air intake riser and the exhaust or relief air riser in close proximity to one another to further improve the performance of energy recovery systems. To do this, it is important to coordinate plans for energy recovery systems early in the design process.

There are two typical types of air-to-air energy recovery: sensible and total. Sensible energy recovery systems transfer only sensible heat. Total energy recovery systems transfer sensible and latent heat. Because of the dry Los Alamos climate, latent heat recovery is typically not important unless the building requires a minimum humidity level.

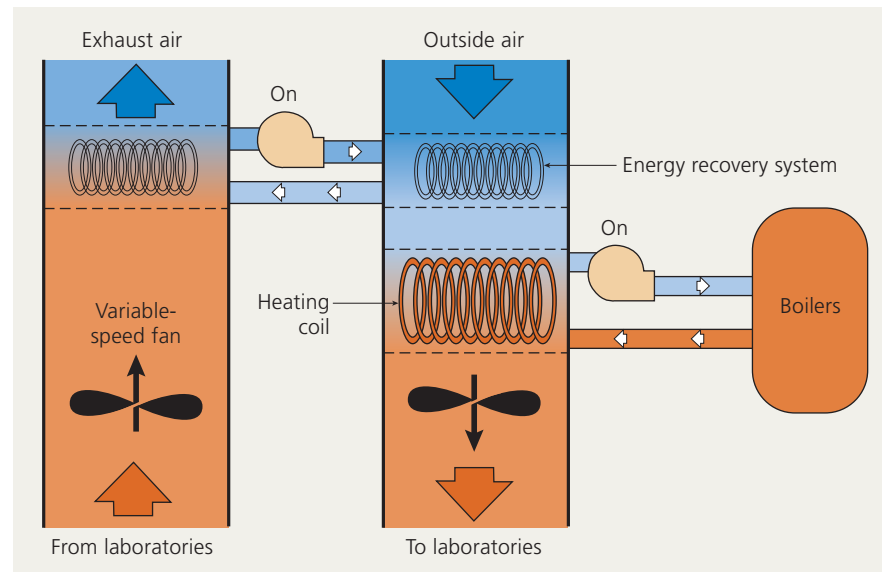

Air-to-air sensible energy recovery system using run-around coils.

Energy Recovery Devices Comparison

Name	Description
Run-Around Systems	<p>A simple piping loop connecting a finned-tube coil in the exhaust plenum with a finned-tube coil in the make-up air plenum or AHU.</p> <p>Does not require supply and exhaust air ducts to be adjacent and does not require a bypass air damper. Requires pump and piping.</p>
Heat Pipe Devices	<p>A heat source boils a heat transfer fluid within a pipe, and a heat sink condenses the fluid back to its liquid state, liberating the energy transferred from the fluid's change of phase.</p> <p>Requires supply and exhaust to be adjacent. Requires a bypass damper and/or tilting controls.</p>
Fixed-Plate Air-to-Air Devices	<p>Typically, coated air-to-air aluminum heat exchangers.</p> <p>May have to be quite large to perform effectively.</p> <p>Requires supply and exhaust to be adjacent. Requires a bypass damper.</p>
Rotary Air-to-Air Energy Exchangers	<p>Recovers latent and sensible heat – highest effectiveness and lowest pressure drop.</p> <p>Previously not recommended because of potential carryover of contaminants from the exhaust to the supply air stream. Purge sectors and good seals minimize cross-leakage.</p> <p>Recent development of a molecular sieve, desiccant-based heat wheel technology that will not absorb large molecules.</p> <p>Requires supply and exhaust to be adjacent. A bypass damper reduces pressure drop when not in use.</p>

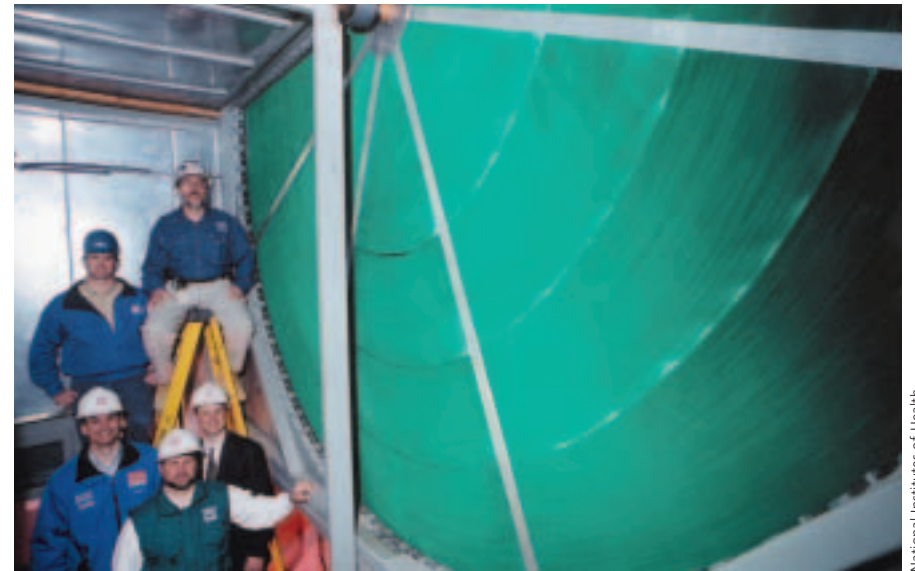

National Institutes of Health

Molecular sieve desiccant energy recover wheel at the National Institutes of Health, Louis Stokes Laboratories in Bethesda, Maryland.

Laboratories for the 21st Century

Laboratory buildings typically consume 5 to 10 times more energy per square foot than office buildings. This high use suggests great opportunities for energy savings. The U.S. EPA and DOE established a program called “Laboratories for the 21st Century” (www.epa.gov/labs21century) to promote and assist in the design, construction, and operation of high-performance, low-energy laboratories.



LABORATORIES FOR THE 21ST CENTURY

Central Plant Systems

Central plant systems comprise the mechanical equipment that heat and cool water (boilers and chillers) to provide heating or cooling to a single or group of buildings. Distribution systems circulate the heated or cooled water through heat exchangers to condition air or meet process loads.

Begin considering the central plant design and obtaining input from other design team members about the building loads, space conditioning requirements,

Advantages of central plants versus dedicated mechanical systems

Central plants –

- Allow for diversity of equipment capacity for multiple buildings.
- Provide future flexibility for increased loads on the system (remember to allow space and accessibility for future expansion).
- Lower maintenance costs because all major equipment is in one location.
- Increase system efficiency because multiple chillers, boilers, and cooling towers can be staged so that they operate near their maximum efficiency and provide useful redundancy. Waterside economizers can also be easily incorporated.
- Reduce amount of space dedicated to mechanical equipment in a building.
- Reduce the noise and vibrations associated with operating combustion- and refrigeration-based equipment by removing this equipment from the building.
- Increase the potential for combined heat and power (CHP) systems.

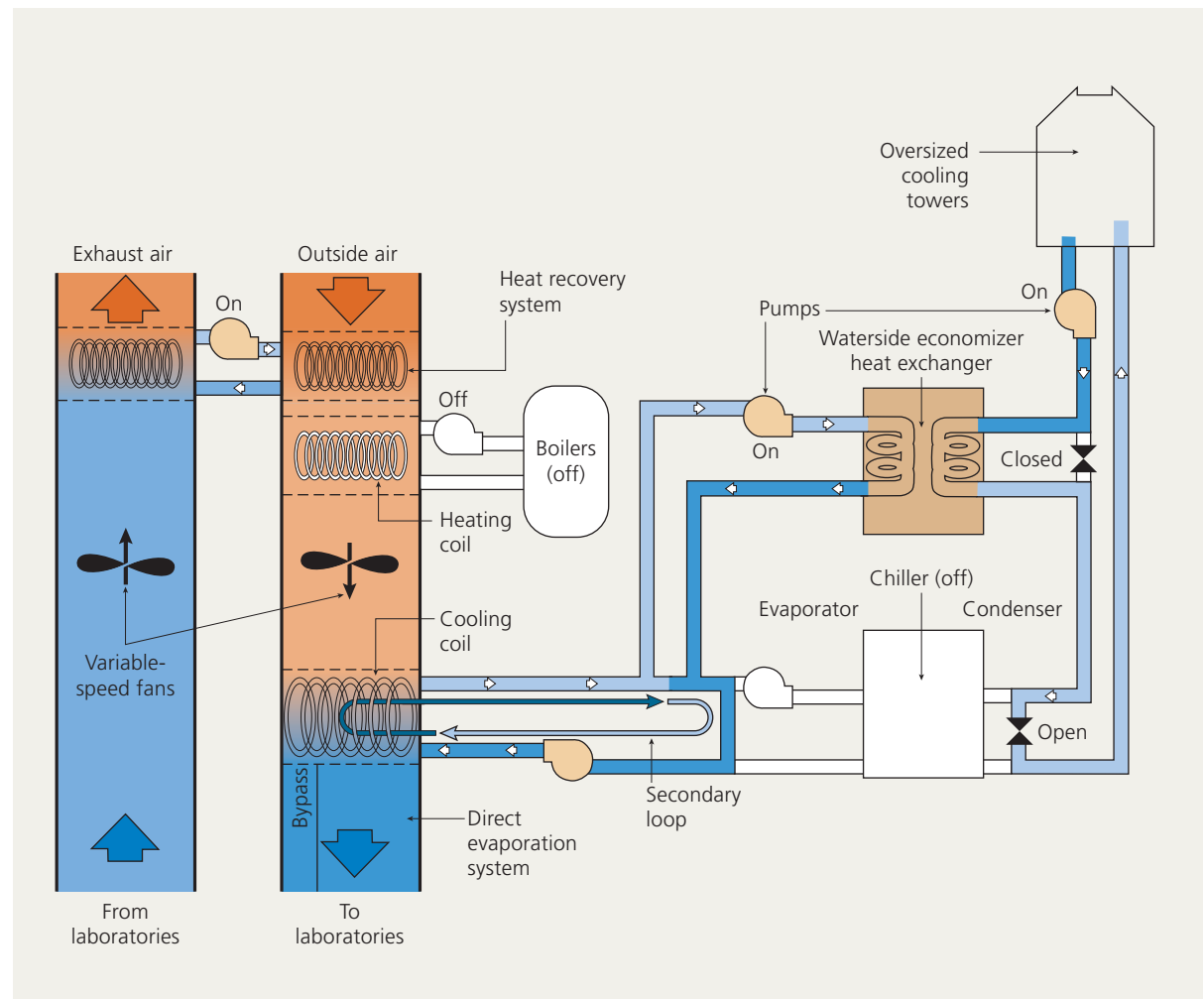

Laboratory space conditioning system operating in the cooling mode using a heat exchanger for a waterside economizer. A cooling tower provides indirect evaporative cooling. A direct evaporative cooling section with a bypass for humidity control further conditions the air before it is delivered to the laboratories.

and process loads early in the design process. Participate in the architectural design activities to minimize building loads, then design the central plant and distribution systems to meet these loads while using the least amount of energy.

Water-side economizers

The low wet-bulb temperatures in Los Alamos are especially suitable for water-side economizer systems. Select chiller systems designed to operate at as low a condenser (tower) water temperature as possible, down to about 50°F. When the CWS temperature is this low, a water-side economizer system can offset the entire chilled water load. Water-side economizer systems are particularly applicable for meeting large cooling water loads such as that which may be required by some laboratory activities. Provide a chiller bypass when using a water-side economizer.

Chillers

Anticipate the actual operating conditions of the chiller and select accordingly. Most chillers operate between 40 percent and 70 percent of capacity a majority of the time and rarely operate at full load. Select chillers with a high-integrated part-load value (IPLV) rating so that they operate efficiently under full and part load conditions.

Consider selecting multiple chillers of different capacities to provide flexibility in meeting varying loads in addition to selecting chillers with high IPLV ratings. It is better to operate chillers near full capacity and start up additional chillers as needed than it is to operate large chillers at part load most of the time.

The energy use of central plant and distribution systems can vary by a factor of two or more based on the system design and operation. For example, an air-cooled chiller operating in Los Alamos will have an energy use of 1 kW/ton or more; whereas, the same sized water-cooled chiller with a cooling tower can have an energy use of less than 0.5 kW/ton.

Achieve improved compressor part-load kW/ton ratings by installing a variable-speed-drive (VSD) on the compressor. The VSD allows the compressor to run at lower speed under part-load conditions.

Refrigerant Options

Criteria	HCFC-123	HCFC-22	HFC-134a	Ammonia
Ozone-Depletion Potential	0.016	0.05	0	0
Global Warming Potential (relative to CO₂)	85	1500	1200	0
Phase Out Date	2030	2020	N/A	N/A
Occupational Risk	Low	Low	Low	Low
Flammable	No	No	No	Yes

Select refrigerants with a zero-ozone-depletion factor whenever possible, especially when the chiller efficiency is not significantly affected by the type of refrigerant.

Operating chillers to provide higher chiller water supply (CHWS) temperatures increases the efficiency and provides greater cooling capacity (tons) for a given chiller size and constant condenser water supply (CWS) temperature. Keep this in mind when selecting coils for the chilled water system. Select coils using a 50°F or higher CHWS temperature. The larger face area of these coils reduces the air velocity and pressure drop across them. Also, designing for warm chilled water temperatures increases the number of hours of potential “free” cooling using a waterside economizer.

Variable Speed Drives

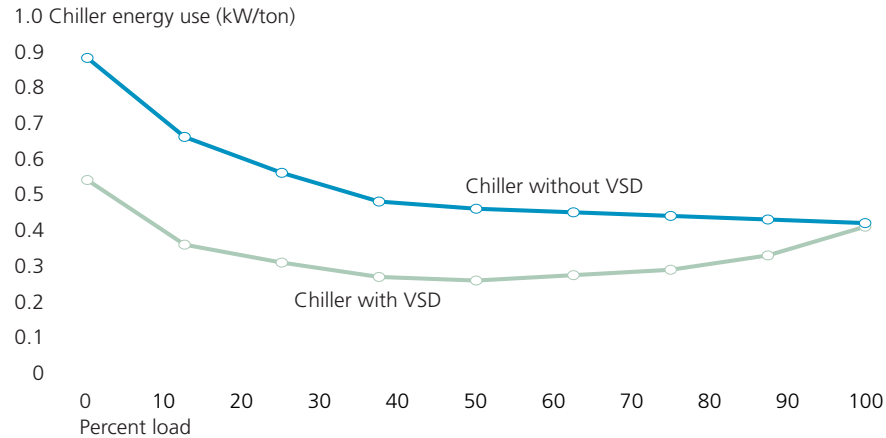

Comparison of the performance of a standard chiller and a chiller using a VSD.

Low- vs. Medium-Temperature Chillers

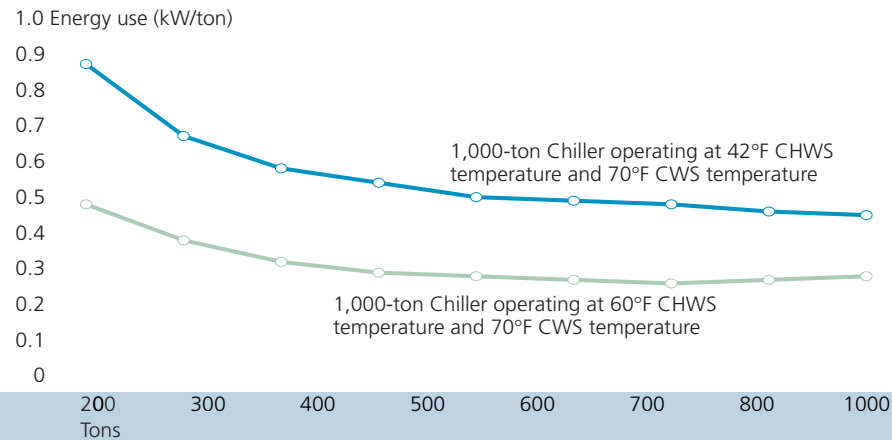

Operating chillers to provide higher CHWS temperatures decreases the chiller energy consumption.



Provide variable-speed-drive (VSD) fans on all new cooling towers. A direct-drive propeller axial cooling tower is usually more efficient than a centrifugal-fan cooling tower. Over-sizing the cooling tower enables condenser water to return to the chiller at a temperature close to the wet bulb temperature, maximizing system efficiency.

LANL



Modular boiler system provides good part-load efficiency and redundancy.

Boilers

Select boilers based on the lowest life cycle cost. In most cases, it is best to purchase high-efficiency condensing boilers. But, if the heating load is small (so the boiler would not be operating very many hours per year), the added cost of these efficient boilers may not be justified. Discuss the various capital costs and full-load and part-load efficiencies with the project team as well as with the boiler manufacturers to determine the right boiler for a particular load.

Consider selecting multiple boilers of different capacities to provide flexibility in meeting varying loads. It is better to operate boilers near full capacity and start up additional boilers as needed than it is to operate large boilers at part load most of the time. Systems relying on multiple hot water boilers are more flexible and result in better peak and part-load performance.



Consider gas-fired radiant heating systems for areas with high ceilings, spot heating, and other applications where radiant heating may be more energy efficient than convective or all-air heating systems.

Condensing Boiler Operating Efficiency

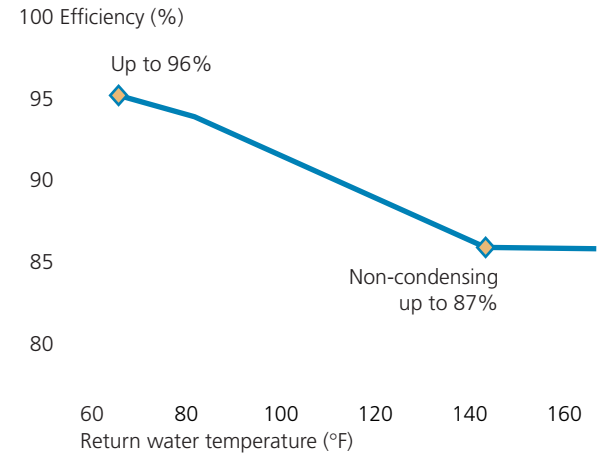

Condensing boilers operate at their highest efficiencies when the return water temperature is below 120°F.

Avoid selecting steam boilers for heating LANL buildings. Steam systems are not recommended because of their typical high maintenance and poor efficiency. Should a steam boiler system be included in the design, consult an experienced boiler manufacturer regarding the boiler, heating surfaces, valves, combustion, condensate, condensate return, flashing, automatic temperature control, steam traps, pressure reduction, and steam metering.

Combined Heat and Power (CHP)

Combined heat and power systems generate both electricity and heat. Consider using CHP systems where the heat can be used for space heating, powering an absorption cooling system, or providing heat for a particular research activity. Size the CHP system so that all the waste heat is used most of the time. One appropriate application of CHP systems is to provide standby (emergency) power instead of installing an emergency generator for a building with a process heat load.

The low cost and high thermal-to-electrical efficiency (23 percent to 27 percent) of micro-turbines are making CHP systems viable in sizes of 30 kW and larger. CHP systems are also developing the reputation of being low-maintenance systems.

Remember to derate the capacity of all combustion devices (e.g., boilers and turbines) at LANL for altitude.

CHP systems reduce peak electrical demands of buildings. If CHP systems are considered for all new LANL buildings, then installing these systems may help delay construction of new high-voltage feeds to the LANL campus. This can be an important factor where available electrical power is limited.

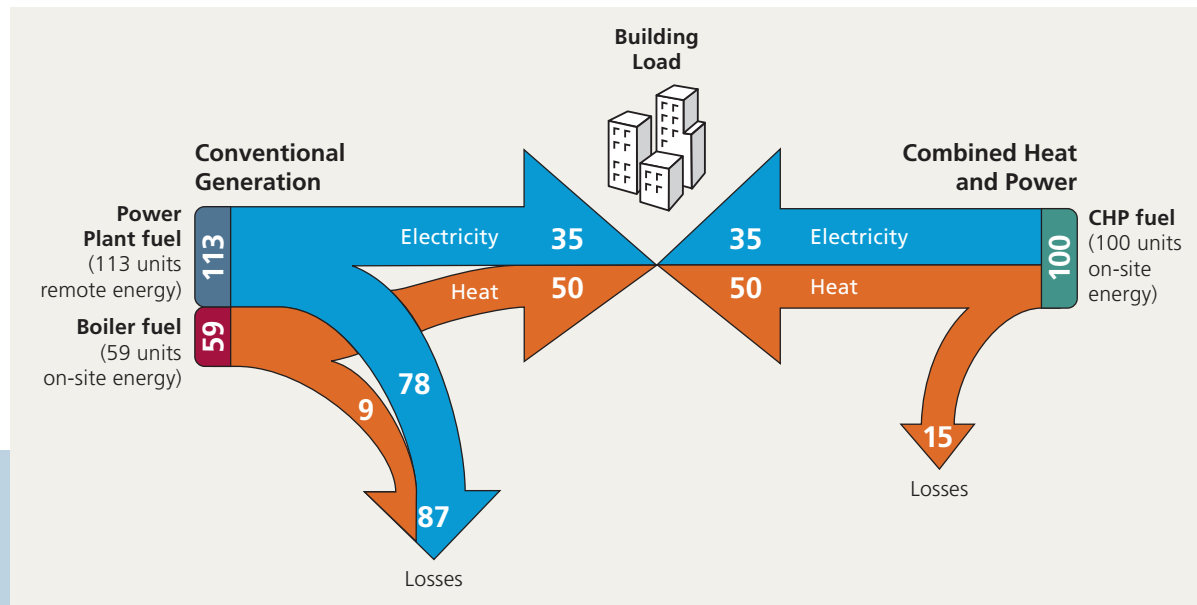

The efficiency of CHP is approximately 85%, compared to about 30% for a typical central power plant. This diagram assumes operation of 1-MW or larger gas turbines or fuel cells.

Heating Systems

The primary heating energy categories are –

- Outside air preconditioning
- Space reheat
- Overcoming envelope heat loss
- Heating domestic hot water and process water.

Precondition ventilation air for freeze protection by using exhaust air heat recovery systems, natural-gas-fired furnaces, or hot water coils. Natural-gas-fired furnaces located in the preconditioning unit can be direct-fired (combustion products go into the airstream) or indirect-fired (combustion products go out a flue). Direct-fired furnaces are more efficient, but only if used in systems needing 100% outdoor air. Use modulation controls with good turndown for all gas-fired units.



Robb Williamson

Smaller solar hot water systems, such as the system installed at the Chesapeake Bay Foundation's Philip Merrill Environmental Center in Annapolis, Maryland, are more common than larger systems, such as that found on the LANL Otowi Building.

Minimize space reheat requirements by supplying air to the space at a temperature appropriate to the loads in that space. Minimize laboratory space conditioning system energy consumption by supplying air as warm as possible to the space when it is warm outside and as cool as possible when it is cold outside.

Guidelines for Laboratory Supply Air Temperatures

A common design error is to condition all air to 55°F before distributing that air to any part of the building. This is an appropriate strategy when supplying air to spaces with low ventilation loads and constant space loads, such as office spaces. Laboratories have high ventilation loads and varying space loads, depending on the activities occurring within the laboratory. Supplying 55°F air to a laboratory with a high ventilation load but a low space load requires that this air be reheated before it enters the space. Cooling the air to 55°F then reheating it wastes energy. Alternatively, supplying 62°F air to a laboratory with high ventilation and space loads requires that that air be cooled before it enters the space. Heating the air to 62°F then recooling it wastes energy.

Suggested Reset Supply Air Temperature Schedule for Laboratories

Outside Air Temperature (°F)	Supply Air Temperature (°F)
< 55	55
56–62	Floats within the dead band; supply air temperature equals outside air temperature
>62	62

Work closely with the architectural design team members during the early design phases to ensure inclusion of a good thermal envelope for the building. Reducing building loads minimize, the need to provide heating system equipment to overcome heat losses through the envelope (see Chapter 4).

There are many variations in hot water system requirements at LANL, from very light domestic hot water (DHW) loads to process-level loads. Typically, the DHW loads are quite small in most LANL buildings. In all buildings, minimize the DHW demand as much as possible by specifying low-flow sink and shower fixtures.

Design the DHW system to meet the anticipated loads (DHW systems are often oversized in commercial buildings). Consider point-of-use hot water systems in buildings with light DHW loads (also known as instantaneous hot water heaters). These systems avoid the

Electricity costs about four times as much as natural gas at LANL. If renewable energy systems cannot be used to provide space and water heating, then select natural gas as the primary fuel source for heating systems.

central hot water storage tank and system circulator pumps found with centralized systems. They save energy by eliminating thermal losses through the storage tank and eliminating the pump loads.

Central gas-fired hot water systems are typically a more efficient solution as the DHW loads increase and to meet process loads. For these systems, be sure to schedule circulator pump operation based on use patterns.



Solar hot water system on the LANL Otowi Building. The excellent solar resources in Los Alamos make solar hot water systems a viable solution for meeting DHW loads and preheating water for process and space heating loads. These systems have a high first cost, but very low operating costs. A year-round water heating load, such as for cafeteria, locker room facilities, and process loads, is required to make solar hot water systems cost-effective.

Distribution Systems

Properly engineered distribution system design, good specifications, and accurate installation result in system that efficiently deliver heated and cooled air or water from the point where it is generated to the point where it is used. In addition to the chillers, boilers, air handling units, and other components discussed so far in Chapter 5, good distribution system design includes effective insulation, condensation control, and minimized air leakage.

The two most common and efficient types of water distribution systems within a building are primary/secondary and variable flow primary pumping systems.

Specify all motors controlled by variable speed drives as “inverter duty.”

Primary/secondary systems provide energy-saving opportunities through variable flow (only pumps the water actually needed to meet the required loads) and

elevated return-water temperature. The cost of variable speed drives has decreased significantly in recent years, resulting in an extremely cost-effective approach to reducing wasted pumping energy. Two-way valves cost less to buy and install than three-way valves.

Issues such as the minimum, maximum, and acceptable change of flow rate through the boilers or chillers, and the installation of a bypass to satisfy the minimum flow through the chiller will affect the design of variable flow primary pumping systems. These systems cost less to purchase and operate than the primary/secondary systems because there are fewer pumps in the system.

Provide controls that automatically reset supply water temperatures by representative temperature changes responding to changes in building loads or by outside air temperatures. It is best if fluid temperatures for heating equipment devices are as low as practical and as high as a practical for cooling equipment, while meeting loads and minimizing flow quantities.

Water Distribution

- Design systems for the maximum temperature differential to improve equipment efficiency and reduce pumping energy
- Vary the flow quantity with the load, using two-way control valves and variable speed pumps
- Design for the lowest practical pressure drop
- Provide operating and idle control modes
- Identify the critical pressure path and size the pipe runs for minimum practical pressure drop when locating equipment
- Specify high-efficiency pumps with high-efficiency (NEMA Premium) motors

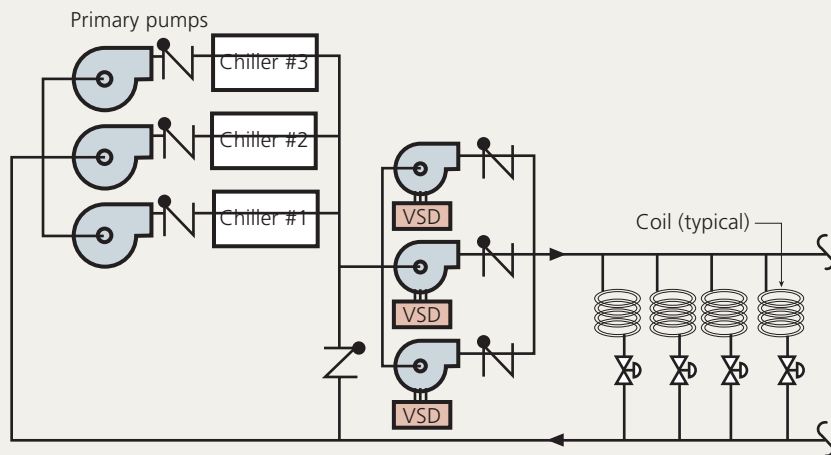

Primary/secondary pumping strategies provide constant water flow through the boiler(s) or chiller(s) and vary the flow through the system with variable speed drives on the secondary pump motors and two-way valves throughout.

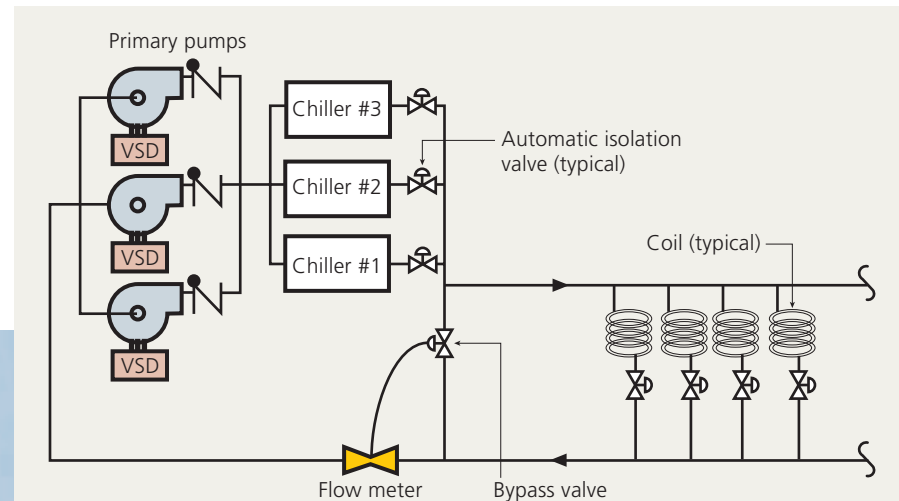

Variable flow primary pumping varies the flow through the boiler(s) or chiller(s) and the coils at the air-handling units, relying on fewer pumps than the primary/secondary strategy.

Plumbing and Water Use

Los Alamos County supplies water to LANL from a series of deep wells drawing water from a regional aquifer that discharges into the Rio Grande river valley. Approximately 88 percent of the discharged water is regulated by the National-Pollution-Discharge-Elimination-System (NPDES) and groundwater (GW) permits. Most discharged water is treated by the sanitary waste system plant or in specialized treatment systems, such as the High Explosives Wastewater Treatment Plant. Non-regulated discharges primarily result from construction activities and landscaping.

Water conservation procedures currently being implemented at LANL decrease maintenance and life cycle costs for building operations and help achieve the water conservation goals of the Laboratory. In addition, facilities that use water efficiently reduce overall costs to LANL by lowering water use fees from Los Alamos County, volumes of sewage to treat, energy and chemical use, and capacity charges and limits.



Sensors that automatically shut off faucets and flush toilets improve hygiene, comply with Americans with Disabilities Act (ADA) requirements, and save water.

LANL Water Consumption

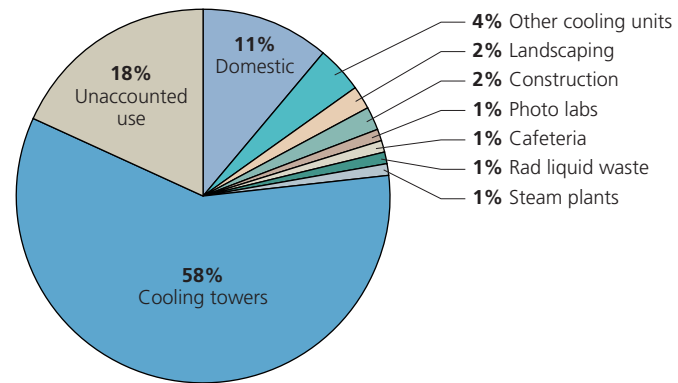

Cooling towers are the largest water consumers on the LANL campus, accounting for 58% of the LANL campus water consumption.

Warren Gretz

Indoor Plumbing Fixtures

Federal law mandates that all plumbing fixtures meet or exceed the minimum Energy Policy Act of 1992 (EPACT) requirements. Specify fixtures that exceed the EPACT requirements, including dry fixture and control technologies, in all new LANL buildings.



Sheila Hayter

Waterless urinals represent the most water-efficient urinal option.

EPACT 1992 Standards for Indoor Plumbing Fixtures		
Fixture	EPACT Requirement	Comments
Toilets	1.6 gallons per flush (gpf)	Flush-valve toilets are typically used in commercial applications because they offer durability and less maintenance compared to gravity tank toilet fixtures.
		Devices sensing motion (ultrasound) and heat (infrared) and timers help avoid double flushing and flushing during unoccupied times, eliminate handling of fixture controls, improve hygiene, and meet ADA requirements.
		It is recommended not to pursue water use reduction beyond 1.6 gpf for toilets.
Urinals	1.0 gpf	Waterless urinals provide first-cost savings (e.g., eliminating the need to provide a water line and flush valve) and less maintenance (e.g., leaks, valve repairs, water overflows, etc.) over conventional urinals.
		Waterless urinals require the use and periodic replacement of a strainer cartridge and sealant fluid.
Showerheads	2.5 gallons per minute (gpm) at 80 pounds per inch ² (psi)	Metering shower systems are typically used for high-use applications such as health clubs.
		When specifying low-flow showerheads, be sure to select those that will supply water at a pressure that is satisfactory to the user.
Faucets	2.5 gpm at 80 psi	Metering and self-closing faucets (faucets that automatically shut off after a certain period of time or when the user moves away) provide water savings by preventing faucets from being left on (or not completely shut off) and preventing overuse.
Metering Faucets	0.25 gallons per cycle (gpc)	Microprocessor-controlled sensor (motion or infrared-sensing devices) valves can be custom programmed to stay on for predefined lengths of time for water conserving needs.
		Sensor-operated faucets improve hygiene, are ADA-compliant, and save water.
		Sensor control devices are usually battery-operated for retrofit installations and hardwired for new construction. They require an electrician in addition to a plumber when maintenance problems occur.

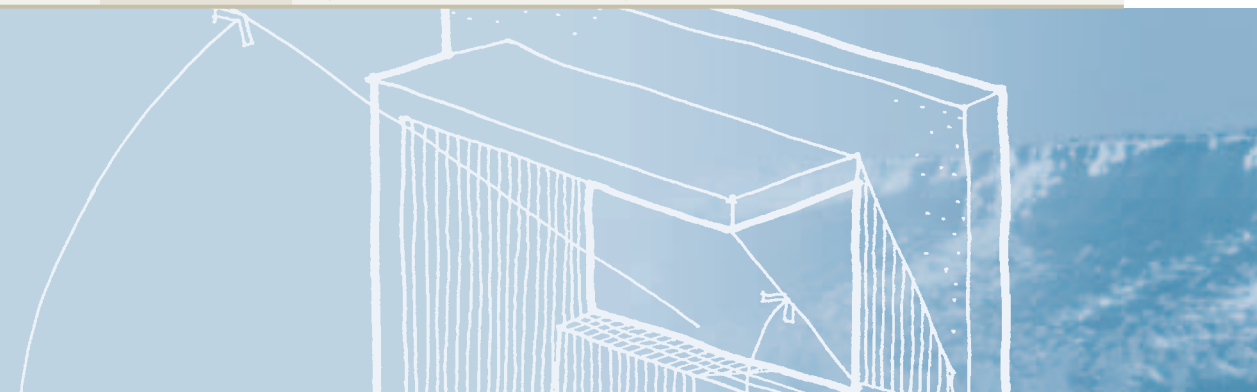

EPACT 1992 Standards for Indoor Plumbing Fixtures

Fixture	EPACT Requirement	Comments
Drinking water fixtures	N/A	<p>Bottled water coolers offer the highest potential for water conservation because dispensed water must be directed into a container such as a glass or bottle.</p> <p>From an overall sustainability point of view, bottled water uses more resources than a drinking fountain because the bottles must be cleaned, filled, and delivered, and must be retrieved when empty.</p> <p>Energy savings can be achieved by either not providing chilled water for drinking, or by ensuring that chillers and heaters for drinking water are energy-efficient and do not operate during unoccupied times (e.g., timers are a low cost means of preventing such chillers from operating continuously).</p> <p>Use only Energy Star qualified bottled water coolers in LANL buildings with bottled water.</p>

Water-efficiency measures in buildings can easily reduce water usage by 30% or more. In a typical 100,000-ft² office building, low-flow fixtures and equipment can save 1,000,000 gallons of water per year or more, based on 650 building occupants each using an average of 20 gallons per day.

Cost Comparisons for Plumbing Fixtures

Fixture	Standard (EPACT)	Better Performance	High Performance for Sustainability
Toilets	1.6 gpf	Same as baseline (1.6 gpf)	Same as baseline (1.6 gpf)
Urinals	1.0 gpf	2x to 3x (for 0.5 gpf)	0.5x to 1x (waterless)
Showerheads	2.5 gpm	No cost increase (for 2.0 gpm)	No cost increase (for 1.5 gpm)
Kitchen Faucets	2.5 gpm	No cost increase (for 1.5 gpm)	No cost increase (for 0.5 gpm)
Lavatory Faucets	2.5 gpm	No cost increase (for 0.5 gpm)	1.5x to 3x (for metering, adjustable cycle, and flow)

Wastewater recycling/reuse (downcycling)

Common uses of recycled/reused wastewater include: landscape irrigation, toilet and urinal flush water, space heating and cooling, and other water-consuming processes or equipment that do not require potable water. Wastewater recycling/reuse and treatment systems provide significant water savings, reduce the costs associated with purchasing and discharging facility water, and reduce site stormwater runoff (see Chapter 7). Consider the following questions when assessing wastewater recycling/reuse systems:

- What are the water reuse opportunities?
- What is the minimum water quality needed for the reuse opportunities?
- How much wastewater will the facility generate?
- What are the wastewater sources that satisfy the water quality requirements?
- How much wastewater should be recycled?
- How extensive a treatment system is needed?
- Where will the treatment system be built?
- What are the implementation costs?
- What are the operational and maintenance costs?
- Will the ultimate savings from reduced water consumption and discharge costs outweigh the cost of the system?
- What is the payback period?



Water-Consuming Mechanical Systems

Cooling towers are the most common type of cooling system for large cooling loads. Make-up water must be added to cooling towers to replace the water lost by evaporation, bleed-off, and drift. Operate cooling towers at the highest possible cycles of concentration to save water.

Sources of make-up water for cooling towers can be once-through cooling system, process wastewater, and treated municipal wastewater effluent. The most water-intensive cooling method is once-through cooling, in which water contacts and lowers the temperature of a heat source and then is discharged. Eliminate once-through systems when possible. If it is not possible to eliminate these systems, then integrate shut-off devices to prevent the water from running when the once-through unit is not operating. Also consider converting once-through systems to recirculating systems by connecting them to cooling towers or chilled water systems.

The New Mexico Environment Department

The New Mexico Environment Department (NMED) encourages the recycling/reusing of wastewater that has not come in contact with food or human waste (typically referred to as greywater). Some level of treatment may be required before waste can be recycled/reused. Contact the NMED (800-219-6157) for wastewater recycling/reuse assistance, such as answering questions, reviewing designs, and obtaining a NMED permit (that may be required for modifying plumbing or disconnecting plumbing from the sewer system).

Robb Williamson

Steam boilers require make-up water to replace blow-down water (periodically released from the boiler to remove accumulated solids and sediments), or to compensate for uncollected condensate (in steam generator systems). The following water conservation and recycling/reuse options are applicable for boiler and steam generator applications:

- Consider a condensate return (recycle/reuse) system that enables otherwise uncollected condensate to be returned as boiler feed or cooling tower make-up water.
- Employ an expansion tank to collect boiler blow-down water and permit cooling (rather than mixing cold water) for recycling/reuse. Consider use of a heat exchanger to preheat boiler feedwater and cool blow-down.

- Depending on water quality considerations, condensate and blow-down may be used for other non-potable-water-consuming applications.

Consider the reuse of once-used deionized water for a different application because deionized water is often more pure after its initial use than municipal. Also consider using reject water from reverse osmosis (RO) systems.

First minimize the quantity of wastewater generated, then implement recycling/reuse of the unavoidably generated wastewater. Consider the following water-efficiency with features and techniques when selecting HVAC equipment and other industrial processes and equipment:

- Avoid single-pass or “once-through” process cooling systems. Consider multi-pass, recirculation, or cooling tower systems.

- Consider connecting equipment to a closed-loop system rather than using a potable water source.
- Adjust overflows from recirculation systems by controlling the rate at which make-up water is added: install float-controlled valves on the make-up lines, close filling lines during operation, and provide surge tanks for each system to avoid overflow.
- Install high-pressure, low-volume nozzles on spray washers.
- Avoid high-volume hoses with high-pressure. Consider low-volume cleaning systems.

Proper operation and maintenance of water-consuming mechanical equipment is another important component to the overall water conservation effort. Keep in mind ease of operation and maintenance of mechanical systems when designing new LANL buildings.



The LANL Nicholas C. Metropolis Modeling and Simulation Center currently uses treated wastewater from the LANL complex for cooling tower application.

Rainwater Harvesting Systems

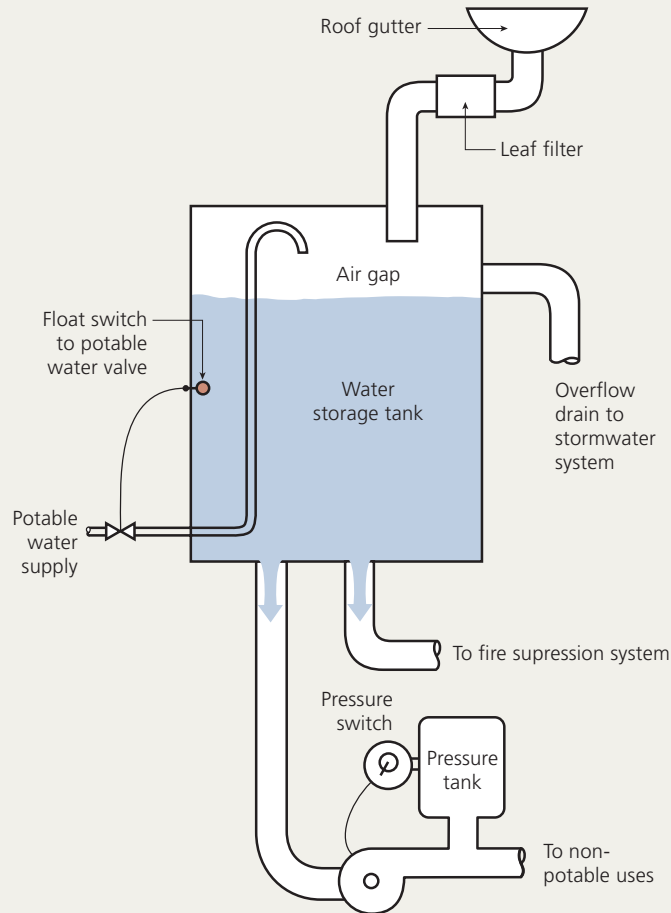

Rainwater harvesting systems collect rainwater runoff from a building roof and store the water in a cistern (water storage tank). A pump transfers water from the cistern to a pressure tank to be used by evaporative cooling systems, toilets, landscape irrigation, and other non-potable water loads. Plan for freeze protection when designing these systems. Capturing and using rainwater reduces that amount of water that needs to be pumped from wells and reduces stormwater runoff. The average historical moisture at LANL is about 18 inches per year. The annual amount of rainwater available for each square foot of roof area at LANL is about 11 gallons. Size the rainwater storage tank for the maximum normal rainfall event (e.g., 90% of the area's storms, not the 100-year events).



Robb Williamson

A rainwater harvesting system on the Chesapeake Bay Foundation's Philip Merrill Environmental Center in Annapolis, Maryland, captures rainwater for use in fire suppression and in the building's sinks.

Building Control Systems

Building energy management control systems (EMCS) control operation of a building's mechanical and electrical systems. A good EMCS design takes advantage of advanced control strategies to meet the building's original sustainable design intent. After commissioning (see Chapter 9), the building operator guarantees the building continues to perform sustainably by adjusting the EMCS to accommodate changes in occupant requests and building functions. Poor building operation will reduce the energy saving benefits of an otherwise good design.

An EMCS is an integrated network of sensors, controllers, actuators, and software. When programming an EMCS, designers typically specify use of reset schedules for supply air discharge temperatures, hot-deck and cold-deck temperatures, mixed air temperatures, variable volume duct pressure and flow, heating water tempera-

ture, condenser water temperature, secondary chilled water loop pressure, and chiller and boiler staging. A good EMCS sequence avoids conflicts between these schedules so that savings achieved by one component are not offset by losses at another component. Evaluate each component control strategy on an individual basis and then determine the cumulative effects of various configurations. Consult with a controls representative to assist in identifying where interferences may occur.

An EMCS saves energy and money by:

- Optimizing the equipment start and stop times (e.g., turning fans off during unoccupied hours).
- Operating the equipment at the minimum capacity necessary (e.g., running the fans in a VAV system at the minimum speed needed).

Load shedding means that non-essential equipment is turned down or off when the building is approaching the set demand limit. Sequential startup of equipment reduces spikes in electrical loads by not allowing simultaneous startup of major electric equipment. Both ensure that the electrical demand for the building or a specific piece of equipment within the building does not exceed a predetermined maximum.

- Limiting peak electric demand.

Direct digital control (DDC) systems, the preferred method of controlling buildings at LANL, use electronic signals to actuate, control, and send/receive input and feedback to/from equipment. Centralized DDC systems monitor the building systems as a whole instead of controlling individual equipment separately, reflecting the basis for designing and operating energy-efficient buildings. Central systems also provide opportunities for remote access through modems or networks and can record historical data about equipment operation that can later be used for troubleshooting and diagnostics.

Design an easy-to-use EMCS

The most important consideration when selecting and specifying an EMCS is ease of use. Standardizing the EMCS to one or two manufacturers who have an open-protocol system will help the LANL facilities personnel become better acquainted with the systems on site and avoid having to learn about multiple types of systems. To further the facility managers' flexibility to monitor and control all LANL buildings, interconnect the EMCS through a network to allow for central monitoring.



Robb Williamson

Guidelines for Designing EMCSs

- Specify and install EMCSs in all new LANS buildings. If a building is very small, such as a transportable office, install programmable thermostats.
- Require a detailed sequence of operation for all systems controlled by an EMCS. The sequence must describe all modes of operation of the system and how they are accomplished.
- Commission EMCSs and periodically check calibration of critical sensors (see Chapter 9).
- Allow as wide a “dead band” as possible for temperature and humidity set points, and increase the dead band during unoccupied hours. Thermostatic controls for office areas can be programmed for a cooling set point of 75°F and heating set point of 72°F. Plan for an adjustable dead band of at least 6°F ($\pm 3^\circ\text{F}$) to reduce the cycling of the heating and cooling equipment and to prevent switching back and forth between the two systems. Having different set point temperatures for heating and cooling seasons increases personnel comfort because people tend to dress according to the season (e.g., warmer in the winter). Also, the temperature and humidity of unoccupied spaces can float (drift beyond the levels required when the space is unoccupied) until the space becomes occupied again or when the space gets too cold (below 55°F).
- Integrate economizer controls with the mechanical cooling (leaving air temperature controls) so that mechanical cooling is only operated when necessary and to avoid over-cooling the supply air.
- Design the systems and controls so that operating the economizer does not increase heating energy use.
- Control VAV systems to have a reset temperature such that one box is always fully open. This strategy reduces the supply duct static pressure.
- Use a sensor for multiple purposes, if possible. For example, a current transducer (CT) may be used to verify that a pump is operating properly and to calculate and record pump energy use. Also, tie occupancy sensors that control the lighting to the VAV boxes serving the same space to control temperature and the amount of outside air (e.g., only condition and supply outside air to the space when it is occupied).
- Provide controls that automatically reset supply water temperatures (heated and/or chilled water) by representative temperature changes responding to changes in building loads or by outside air temperatures.
- Use lockouts based on time of year or outside temperatures to prevent simultaneous operation of the heating and cooling systems.

Electrical Power Systems

The cumulative pollution burden of producing electricity is three times that of a building's electrical load at the building site. Ensuring efficient transfer and consumption of electricity within a building will save money, because less electricity is needed, and will reduce the amount of pollutants emitted at the power plant to produce the electricity that the building consumes. Improve the efficiency of building electrical power systems by:

- Using higher voltage power distribution systems in buildings, such as 480/277 volts where electric codes allow. High-voltage distribution systems can result in better economics, smaller conductor sizes, and less energy consumed in the system due to lower line losses.
- Sizing transformers as close as possible to the actual anticipated load to avoid oversizing and to minimize fixed thermal losses. When possible, distribute electric power at the highest practical voltage and power factor consistent with safety.

Green certificates

Purchasing “green power” is one way to minimize the environmental burden of using electricity generated using fossil fuels. Purchasing green certificates (also known as green tags, renewable energy certificates, or tradable renewable certificates [TRC]) represent the environmental attributes of power generated from renewable electric plants. Several organizations offer TRCs. The approximate cost of TRCs is 2¢/kWh. These certificates support power generation from newly developed power generation facilities that use renewable energy technologies (power from the sun, wind, geothermal, low-impact hydropower, or biofuels). For more information see: www.green-e.org/your_e_choices/trcs.html.

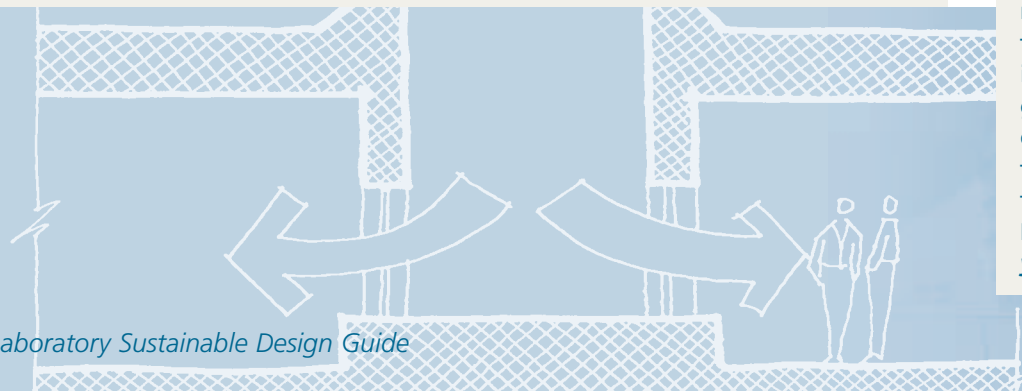

Electricity for LANL is generated mostly from burning fossil fuels (primarily coal). Only about one-third of the energy of the source fuel is delivered to the end user as electricity. The rest is lost in inefficiencies in generation and distribution (see diagram on page 106).

- Comply with the National Energy Managers Association (NEMA) criteria for premium transformers to reduce the no-load (core) losses and the coil (winding) losses during transformer operation. The resulting energy savings will range from about 30 percent at no-load to about 10 percent at full load. Always specify ENERGY STAR transformers.
- Specify higher-efficiency, liquid-filled transformers. These transformers typically use oil as a combination coolant and insulating medium and they are most frequently installed outdoors.
- Select energy-efficient electrical motors to reduce building electricity consumption. It is best if all motors one horsepower and larger are three-phase and “NEMA Premium.”

Los Alamos experiences excellent solar resources. For this reason, consider integrating solar electric systems (PV), into the design of new buildings. PV panels produce DC electricity from sunlight. If AC power is required, an inverter converts the DC electricity to AC.

Uninterruptible power supply (UPS) systems provide electricity when grid power fails. UPS systems consist of rectifiers, battery storage, inverters, and controls to convert AC electricity to DC for the storage batteries, and back to AC for the load. The batteries are typically sized to meet the load for 10 to 15 minutes. All UPS systems consume energy to maintain a charge in the batteries. Avoid UPS systems unless the mission requires them.

Two types of UPS systems exist: on-line UPS and standby UPS. An on-line UPS feeds the entire load through a rectifier to a DC bus that serves the batteries. The DC power is converted to AC power to serve the load. This design eliminates grid disturbance; however, it is less efficient than the standby design because the entire load passes through a rectifier and an inverter.

If an on-line UPS system is chosen, it can be augmented with solar electric (PV), power at the DC bus voltage. This arrangement saves the inverter cost in a grid-tied PV system. It also provides a

longer run time for the UPS system if the power failure occurs during the daytime because the PV system will feed part of the load.

A standby UPS system exposes the load to utility power during normal operation, if utility power fails a switch transfers the load to the UPS system until the utility power becomes available. A standby type UPS cannot readily accept PV augmentation because the load is not normally served by the UPS.



Ryan Ault

A PVIUPS system provides backup power for the Site Entrance Building at the National Renewable Energy Laboratory (NREL) in Golden, Colorado. The generator's 600-watt PV array charges a storage system of eight rechargeable batteries and enables NREL's security staff to maintain critical functions during power failures.

void imbalanced supply circuits

Use three-phase equipment when possible. If single-phase loads exist, such as single-phase motors and plug loads, distribute these loads evenly among the three phases.

PV electricity is not currently cost-effective for most applications at LANL because of the low cost of grid electricity. These systems can be cost-effective for applications where the power grid location is more than ¼ mile away from the building site and when trenching would otherwise be required to bring power to signs or outdoor lighting.

The lifetime operating cost of PV systems is low and these systems can help protect LANL from future electricity shortages.

Metering

Monitor the actual performance of individual LANL buildings through metering. In new buildings, metering verifies that sustainable design and operational goals are met or detect when the buildings are not performing as designed. Metering also helps identify opportunities for improving performance in existing buildings.

Record both electrical consumption (kWh) and electrical demand (kW) to determine building performance. Electrical demand is the time average value over a sliding 15-minute time frame. The LANL automated meter reading system is capable of recording consumption and demand (see Appendix D).

The Federal Energy Code 10CFR434 (see Appendix A) requires buildings with a connected service of over 250 kVA to have provisions (sufficient space to attach portable or permanent metering) for submetering the electrical consumption of HVAC&L systems and large equipment loads. According to the 10CFR434 guidance, the following is recommended for LANL:

Metering alone cannot save energy; however, regularly collecting and recording meter data and looking for unexplained changes can be a tool for assessing and identifying performance problems.

- Install submetering equipment for measuring lighting loads, HVAC system loads, and equipment loads of more than 20 kW.
- Further subdivide the HVAC system metering to separately measure ventilation fan use and cooling plant use for large buildings with complex HVAC systems, such as laboratory buildings.
- Install gas meters in all LANL buildings having gas service, preferably connected to the automated meter reading system. Separately sub meter large process gas loads, if they exist.
- Install water meters in all LANL buildings with water service, preferably connected to the automated meter reading system. Separately sub meter large water use systems, such as a cooling tower.

LANL site-wide metering program

LANL has established a site-wide metering program for recording electricity, gas, and water use data via the local area network (see Appendix D). All new LANL buildings can install meters and connect to this system.



The skylighted entryway at the Thoreau Center for Sustainability at Presidio National Park, San Francisco, California, uses photovoltaic cells that are laminated to the skylight glass to produce electricity as well as to shade and daylight.

Lawrence Berkeley Laboratory

	<i>Standard Practice/</i>	<i>Better</i>	<i>High Performance</i>
Zoning	<input type="radio"/> Zoning only by floor	<input type="radio"/> Zoning by function of laboratory and office	<input type="radio"/> Zoning by load analysis that includes envelope analysis and function analysis
System Design	<input type="radio"/> Aggregation of zones into systems	<input type="radio"/> Multiple systems used	<input type="radio"/> Multiple systems used with zones arranged by function
System Sizing	<input type="radio"/> Rules-of-thumb and base-line sizing tools used	<input type="radio"/> Equipment sizes reduced to account for daylighting contribution (no lights on)	<input type="radio"/> Hourly simulations on each zone with good diversification factors; daylighting and overhangs incorporated into simulations
System Selection – Labs	<input type="radio"/> VAV with no outside air control	<input type="radio"/> VAV supply and exhaust	<input type="radio"/> VAV plus energy recovery
System Selection – Offices	<input type="radio"/> VAV with no outside air control	<input type="radio"/> VAV with CO ₂ monitoring for outside air	<input type="radio"/> Displacement ventilation with CO ₂ outside air control and VAV supply
Ventilation Flow Rate	<input type="radio"/> Constant-volume system	<input type="radio"/> Flow rate less than 1.5 cfm/ft ²	<input type="radio"/> 1 cfm/ft ² net lab area, less than 0.5 cfm/ft ² when unoccupied
Exhaust Stack Design	<input type="radio"/> Fixed-speed exhaust for each device	<input type="radio"/> Multiple fans on central manifold	<input type="radio"/> Multiple stacks with variable-speed exhaust fans
Chillers	<input type="radio"/> Air-cooled DX with evaporator in air handler	<input type="radio"/> Air-cooled chiller producing chilled water, cooling coil in air handler	<input type="radio"/> High-efficiency (less than 0.5 kW/ton) full-load and part-load chiller with cooling tower; set total delivered cooling energy performance including tower, chiller, and pumps to less than 0.55 kW/ton; water-side economizer
Heating	<input type="radio"/> Gas-fired boiler with on-off controls	<input type="radio"/> Modular boilers	<input type="radio"/> Modular condensing boilers with low return water temperature; gas-fired radiant heating for areas with high ceilings; direct-fired modulating natural gas furnaces in 100% outside air units

	<i>Standard Practice/</i>	<i>Better</i>	<i>High Performance</i>
Combined Heat and Power	<input type="radio"/> Not considered	<input type="radio"/> Limited capacity installed	<input type="radio"/> Used in conjunction with emergency power loads and base-line power production when heating is required
Water Distribution	<input type="radio"/> Constant flow	<input type="radio"/> Primary/secondary with variable-flow and variable-speed drives on secondary pumps	<input type="radio"/> Variable-flow primary pumping with variable-speed drives
Metering	<input type="radio"/> No building-level metering	<input type="radio"/> Building-level metering of gas, water, and electric; tie to central metering system	<input type="radio"/> Submetering for plug loads, process loads, lighting, chillers, ventilation loads
Controls	<input type="radio"/> Programmable thermostats	<input type="radio"/> Stand-alone DDC	<input type="radio"/> Networked EMCS, standardized on one or two vendors, EMCS commissioned and periodically checked for calibration of critical sensors, wide deadband for temperature and humidity levels.
Electrical Distribution System	<input type="radio"/> No alternative electrical energy resource used	<input type="radio"/> High-efficiency equipment	<input type="radio"/> 5% green power, PV power meeting 1% of building load. 10% green power, highest efficiency equipment available, PV power meeting 5% of building load

References

Energy Information Agency (EIA), www.eia.doe.gov

ENERGY STAR Commercial and Industrial Transformers, http://yosemite1.epa.gov/Estar/consumers.nsf/content/comm_indust_transformers.htm

FEMP: "How to Buy a Premium Energy-Efficient Motor," www.eren.doe.gov/femp/procurement/pdfs/motor.pdf

Sustainable Building Technical Manual, www.sustainable.doe.gov/pdfs/sbt.pdf

American Society of Heating, Refrigerating, and Air-Conditioning Engineers, www.ashrae.org

Illuminating Engineering Society of North America, www.iesna.org

Laboratories for the 21st Century, www.epa.gov/labs21century

ENERGY STAR Purchasing, www.epa.gov/nrgystar/purchasing

FEMP: *Greening Federal Facilities*, www.eren.doe.gov/femp/techassist/green_fed_facilities.html

"UFEMP Resources: "Regulations and Legislative Activities," www.eren.doe.gov/femp/resources/legislation.html

"Underfloor Air Distribution: Lessons Learned." Allan Daly, ASHRAE Journal, vol. 44, no. 5, May 2002.

EPA's National Pollutant Discharge Elimination Systems (NPDES), <http://cfpub.epa.gov/npdes>

Americans with Disabilities Act, www.usdoj.gov/crt/ada/adahom1.htm

New Mexico Environment Department, www.nmenv.state.nm.us

NEMA TP-1, Guide for Determining Energy Efficiency for Distribution Transformers. National Electrical Manufacturer's Association (NEMA), www.nema.org

Additional Resources

Building Energy Software Tools Directory, www.eren.doe.gov/buildings/tools_directory/subject.html

2002 Buildings Energy Databook. U.S. Department of Energy, <http://buildingsdatabook.eren.doe.gov>

"Buying Energy Efficient Products, Federal Energy Management Program (FEMP)," www.eren.doe.gov/femp/procurement

Federal Energy Management Program, www.eren.doe.gov/femp

